

# Qwik Connect

GLENAIR 9 ■ VOLUME 13 ■ NUMBER 4

**MS  
Backshell  
Wall Chart  
Inside!**

*Out of This World:  
Connector Accessory  
Lollapalooza!*

**G**lenair®

Glenair Interconnect Solutions and...

# THE RACE FOR SPACE

The Cold War between the Soviet Union and the Western powers led by the United States was in full vigor by the early 1950's. The formation of military coalitions, a budding nuclear arms race, secret espionage programs and aggressive economic and technological competition were pronounced expressions of the conflict. While much of the Cold War was played out in secret or in proxy wars, one facet of the war was extremely public: The Space Race. The early days of the race for space focused on the development of rocket technologies, or launch vehicles, capable of delivering large payloads into space. Sergey Korolyov and Kerim Kerimov were the principal architects of the Soviet program, while Wernher von Braun directed the

United States effort.

When the Soviet-built Sputnik I became the first successful man-made satellite in space, and the Russian dog "Laika" became the first living creature to experience low-earth orbit, the battle for space dominance was truly on. As reports of an ever successful Soviet space program accumulated, pressure mounted in the United States to define space exploration as a national priority.

The world's first manned space flight was undertaken on April 12, 1961, when cosmonaut Yuri Gagarin made one orbit around the Earth aboard the Vostok 1 spacecraft. The United States became the second nation to achieve manned spaceflight, with the suborbital flight of astronaut Alan Shepard aboard Freedom 7, as part of Project Mercury. National pride was a significant motivator driving the pace of launch vehicle and payload technology development. For those who experienced the race for space "live," the drama and excitement was palpable. And although Glenair never made the headlines, we were right there in the thick of the battle, producing an innovative range of interconnect products for the aircraft, missiles and the space industries.

Glenair History Lesson:

**FROM SPACE-GRADE CABLES TO THE G1 CONNECTOR ADAPTER AND CLAMP**

Glenair had its beginnings as a military-grade cable shop founded in Glendale, California in 1955. Pacific Automation Products, Inc. built complex, multi-conductor cables for ICBM missile and space launch vehicle applications. Located adjacent to a runway in Glendale's Grand Central Air Terminal, "PAPI" developed innovative methods to build jacketed cable assemblies longer than the then existing maximum of 250 feet. PAPI workers would lay out the multi-conductor cables, sometimes up to 1,000 feet in length, on the airport landing strip and



Wernher von Braun (1912 – 1977) a German American rocket physicist and astronautics engineer, universally recognized to be the preeminent rocket engineer of the 20th century.



Before LAX or Burbank's Bob Hope International, the first and most important air travel center in the Los Angeles area was Grand Central Airport in Glendale. Grand Central offered the first paved runway west of the Rocky Mountains and served as the departure point for the nation's first transcontinental airline service. Grand Central Airport appeared as a backdrop in many early films including Casablanca and was also the early home of Pacific Automation (PAPI) the antecedent of Glenair, Inc.

carefully blow on neoprene jacketing—struggling to keep the material from popping due to the tarmac's heat and the air pressure used for inflation. By the way, this jacketing technique, eventually perfected, is still in use today in Glenair's cabling operation.

Interestingly, even though these connectorized cables were destined for use in extremely high-tech space systems, their design was relatively simple by today's standards. At the time, electromagnetic interference (EMI) was still not much of a concern, due to the limited number of electronic devices used in aerospace applications. In fact, most interconnect cables were equipped with simple strain-relief clamps and little else to protect the connector and cable from damage. But the rapid expansion of radio and other wave spectrum devices in aircraft and space systems heightened the number and severity of EMI and RFI problems. Pacific Automation was an early leader in the design and development of metal-wire braid shielding innovations to prevent EMI from grounding to cable conductors. The new braided material effectively shielded sensitive electronic equipment from EMI noise sources such as engine magnetos.

Most mil/aero connector companies in the 50's shipped their connectors with a simple cable clamp for strain-relief. But there was no connector rear-end standardization across the industry and every connector company basically followed their own design for the number and size of threads and interlocking teeth they would incorporate onto the back-end of the connector. The increased use of braided shielding added additional complexity, as the need for shield termination backshells was fast becoming a universal requirement. But again, each connector company took a unique approach to solving the problem and controlling mil-specs were only just being formulated and enforced.

So, the clever folks at Pacific Automation Products decided to help their cable customers—stymied by the proliferation of non-standard thread geometries and the new shield termination technologies—by launching a line of connector adapters that could be used across the broad range of mil/aero connectors. And since PAPI wanted to sell the new backshell products to all the other cable shops producing military-grade cable assemblies, they set-up

their new backshell enterprise as a separate entity to avoid potential conflicts with their erstwhile competitors. And so Glenair was born.

Located directly across the street from PAPI, Glenair took its name from the city of Glendale and the company's street address on Air Way. Glenair's first product, the G1 connector adapter and cable clamp, covered all the high reliability mil/aero connectors then in existence. And in case you are wondering, yes, we still produce and stock the G1 part. The rapid growth of the aerospace industry in Southern California meant Glenair's growing line of connector accessories was in high demand. And soon the success of the startup backshell business had far outstripped that of the original enterprise PAPI. And so, following a series of organizational changes, the parent company PAPI reversed roles to become the cable division of the now prospering start-up. 53 years later, Glenair is still in operation at 1211 Air Way in Glendale, California and we are still making cables, backshells—and a whole lot more—adjacent to the former runways of Grand Central.



Throughout the ensuing years, Glenair has continued its tradition of innovation with new wire protection, shield termination and other connector accessory solutions. We started with the simple idea that the industry needed standardized connector accessories to accommodate cable clamps, backshells and other hardware to fit the many specialized circular and rectangular connectors in use in high-reliability interconnect systems. This issue of *QwikConnect* is designed to give you a complete overview of these essential connector accessory products.

At Disney they say "it all started with a mouse." At Glenair it was an industry-standard cable clamp, the G1. From this humble beginning Glenair has evolved into one of the world's premier interconnection manufacturers with a dozen full-spectrum product lines designed to meet every high-reliability interconnect requirement. In the pages that follow we present a virtual cornucopia of useful information for the buyer and user of Glenair's "Out of This World" line of connector accessory products. For a free sample of any of our connector accessory products, please call the factory or contact your local Glenair Sales Group.

## Engineering: A Matter of Facts



Greg Brown, Vice President, Engineering

Glenair is a component manufacturer and, as such, is rarely in complete control of the larger systems to which our parts contribute. Nonetheless, we know that small problems at the component level can have significant impact on system performance.

Whether from a mil-spec or a customer, specifications can sometimes be ambiguous or inadequate. That's why we've found it's never enough to just say that a design "meets the spec." Our consistent goal is that the component truly solves the customer's problem. By our reckoning, rigidly designing to spec is the surest pathway to unforeseen engineering failures.



### The Glenair Suite of Connector Accessory Documentation: Circular, Rectangular, Composite and Mil-Spec

We have a great team of engineers and application specialists at Glenair—in fact we believe it to be the largest and most experienced in the industry. And everyone on the team is dedicated to our philosophy of "solving the problem" versus simply "following the spec." Sales and marketing drawings are one of the principal engineering outputs that help customers choose the right product for each application out of the thousands of available options. Our engineering group also completes in-house as well as qualification-related testing to ensure customers may be thoroughly briefed on the performance attributes of our products.

In both instances, we are committed to making decisions based on objective facts and direct observations. It's our sense that basing important decisions on guesses, assumptions or wishful thinking can only lead to failure. As we like to say: "we manage by fact because the alternative is so ugly."

In this same vein, Glenair engineers understand that their profession is governed by a code of ethics published by the National Society of Professional Engineers. The key points of the code are:

- Keeping the need for public safety highest in mind
- Staying within ones area of competence
- Being truthful when speaking as a professional
- Being faithful to the client
- Practicing honorable conduct at all times.

We don't claim that we never make mistakes. But we are sincere when we tell our customers that they will always get our honest best, *and the straight facts*, when it comes to Glenair engineered products.

## Backshells at Work

The broad range of backshell types available today make it critical for interconnect engineers, and others tasked with the responsibility of specifying connector accessories to become adept at building backshell part numbers. For the most part, the process entails selecting options from the part number development trees.

But experience shows it is equally important to consider the working environment of the target application before completing the backshell selection process. There are many electrical, mechanical and environmental considerations which, when properly addressed, will ensure a long functional life for the interconnect system.

The *Backshell Selection Guide* on the following pages presents a step-by-step explanation of this process. But before we delve into the exciting details of backshell part number development it is worthwhile to digress for a moment and talk about cables and conduit.

### Cable and Conduit Make-up

Some very basic questions in the backshell selection process cannot be answered without an understanding of the overall make-up of the wire and cable used in the assembly. Basic dimensional decisions on cable entry size (see Table I on the opposite page) cannot be specified without accurate descriptions and measurements of the cable or wire bundle. A basic analysis of the cable should include:

- Wire Numbers and Types: twisted shielded pairs, coaxial power, signal, fiber optic, etc.
- Shield Material Gauge, Number and Type: tin, nickel, silver plated copper wire, and so on.
- Jacket material properties.

In addition to standard cables, many customers prefer to use circuit protection products such as convoluted tubing and/or metal-core conduit. These products also employ backshell-like devices to assist in the routing of wires or connection to feed-through fittings and connectors. Conduit systems are intended for use in airframe applications, military vehicles, rail, shipboard and transportation systems that require performance attributes not supplied by cable.

The wire harnesses under the hood of your automobile, for example, are rarely enclosed in cable jacketing as the complexity of the routing and the sheer number of interconnected devices makes this an impractical choice. There are obviously many ways to protect wiring, and the choice of which product to use depends on the nature of the potential electromagnetic interference, environmental damage and physical abuse experienced by the assembly. Other factors, such as the ability to readily open the system for repair, add or subtract individual wires from the assembly, or reduce weight also come into play. While the following selection guide is clearly geared to cabled systems, Glenair also supplies an equally broad range of choices for conduit. See [www.glenair.com](http://www.glenair.com) for additional information.



*The heart of every interconnect cable assembly is the multi-conductor cable. As early in the application development process as possible it is critical to document the wire gauges, core type, insulation/dielectric materials, media types (copper, aluminum or optical), shielding (individual conductor and overall), jacketing, and all other elements that contribute to the mechanical and dimensional properties of the cable. By the way, Glenair's cable shop can supply the cable, particularly for unusual or short run applications.*

## Calculating Wire Bundle Diameter

A backshell's rear cable entry can accommodate only a narrow range of cable diameters. When selecting the backshell cable entry size from the provided tables, it is a good idea to err on the side of too large, as an undersized cable can always be enlarged with tape or a grommet to fit the cable clamp. When calculating wire bundle diameters, note that the gauge of the wire describes only the diameter of the metal conductor, and not the overall diameter including insulation and/or braids. Refer to the appropriate wire specification for the actual diameter of the wire for use in the following calculations.

Steps	Calculations
(1a) Determine average wire diameter when all wires are the same diameter; or	Given 30 Wires @ .045 DIA <b>Avg. Wire DIA = .045</b>
(1b) Determine average wire diameter when wires are different diameters.	Given 15 Wires @ .045 and 15 Wires @ .135 $15 \times .045 = .68$ $15 \times .135 = 2.03 + \frac{2.71}{30} = .090$ <b>Avg. Wire DIA</b> $\text{_____} = 2.71$
(2) Multiply average wire diameter by factor from Table I below	(1a) $.045 \times 6.7 = .3015$ <b>Core Wire Bundle DIA</b> (1b) $.090 \times 6.7 = .603$ <b>Core Wire Bundle DIA</b>
(3) Add thickness of any shielding or jacketing to core wire bundle diameter (for example, add .025 for braided sleeving)	(1a) $.3015 + .025 = .3265$ <b>Wire Bundle Outside DIA</b> (1b) $.603 + .025 = .628$ <b>Wire Bundle Outside DIA</b>

No. of Wires	1	2	3	4	5	6	7	8	9	10	12	14	16	18	20	24	28	32
Factor	1.0	2.0	2.2	2.4	2.7	2.9	3.0	3.3	3.8	4.0	4.3	4.6	5.0	5.3	5.6	6.0	6.5	6.9
No. of Wires	36	40	45	50	55	60	65	70	75	80	90	100	125	150	175	200	250	300
Factor	7.4	7.7	8.1	8.5	8.9	9.3	9.7	10.1	10.5	10.9	11.6	12.2	13.7	15.0	16.1	17.2	19.3	21.0

BORN IN THE



Domestic Materials  
Domestic Labor

Glenair backshells are manufactured at our 1211 Air Way factory (some 450,000 square feet) in Glendale, California. Vertically integrated, Glenair directly manages all aspects of fabrication including die-casting, precision machining, plating, and assembly. While we would be the first to agree that quality products are made all over the world, we are nevertheless proud to earn and keep our customers' trust and loyalty with products made right here in Southern California.

## Backshell and Connector Accessory Glossary of Essential Terms

**Adapter:** Generic term for a threaded shell that facilitates the attachment of cable-clamps and other accessories to the back end of a cylindrical connector.

**Angle/Profile:** The straight, 45° or 90° configuration of a connector backshell. Allows system designers to specify the exact route a cable will take as it enters/exits the back end of the connector.

**Backshell:** Any one of thousands of end-bell shaped connector accessories that provide EMI shield termination, environmental sealing or other functions when attached to the back end of a connector.

**Band Porch:** The area on an EMI shield termination backshell where braided cable or wire shielding is terminated (attached) by means of a banding strip, crimp ring or other device.

**Bent Tube:** Manufacturing process used to fabricate angled parts. The smooth, full-radius bend is often specified for fiber optic media or other wire types with bend radius restrictions.

**Connector Accessory:** Generic term for the broad family of parts designed to improve the performance of connectors by providing cable strain-relief, environmental sealing, EMI shield termination and so on.

**Coupling Nut:** Threaded portion of the backshell that enables reliable attachment of the connector accessory to the back end of the connector. Various styles such as free-spinning and self-locking are specified depending on application requirements.

**Cable Entry/Exit:** In a correctly sized backshell, the OD of the cable will fit easily into the rear-end of the backshell but not be too loose as to limit the effectiveness of the cable clamp. In backshell part number development the cable entry/exit is

generically referred to as the “dash number” and is selected from a table according to the diameter of the cable.

**Crimp Ring:** Malleable aluminum band, typically factory installed, used to terminate (attach) braided cable shielding to a backshell.

**Cable Clamp:** Simple strain-relief device, typically made up of saddle-bars and fasteners, used to prevent wires and cables from being pulled from the backend of a connector.

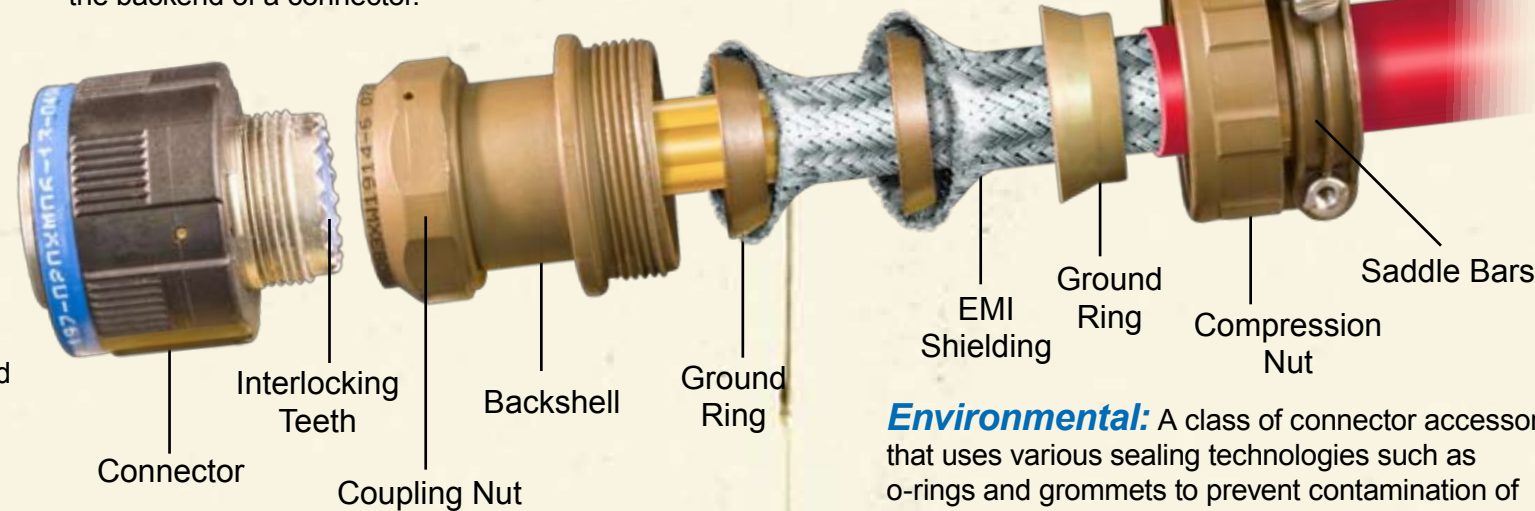

**Cut and Welded:** manufacturing process used to fabricate angled backshells, when a tooled (die-cast) equivalent does not exist.

**Commercial:** Term used to refer to connector accessories (or other interconnect components) that are built to non-mil-spec specifications. Typically commercial backshells are preferred when a particular feature is not available in the applicable mil-spec.

**Connector Designator:** Alphabetic code used in connector accessory part number development used to indicate the series of connector the part is designed to fit.

**Dash Number:** Numeric code used in backshell part number development used to indicate the inside diameter of the rear opening of a part.

**Die Cast:** Metal part fabrication process in which molten aluminum is shot into a die (a type of mold) under high pressure. Die cast parts require expensive tooling on the front end but are considered less costly to produce over time.

**Extender:** Backshell component part used to lengthen the enclosed and protected area behind the connector. Typically used to house wire service loops or simply to provide extra working room for contact termination.

**Environmental:** A class of connector accessory that uses various sealing technologies such as o-rings and grommets to prevent contamination of the wire-to-connector contact area.

**Finish/Plating:** The application of conductive and non-conductive materials to the surface of the connector or backshell, typically via an electrochemical process. Surface plating provides corrosion protection and a ground path for EMI.

**Mil-Spec:** Controlling specifications, originally authored and maintained by various branches of the military governing the form, fit and function of connector accessories and other products used in military equipment. Many mil-specs, such as the AS85049 backshell specification, are now maintained by third-party commercial organizations such as the SAE.

**Nut-Ring:** Connector accessory used as an aid in attaching receptacle connectors to bulkheads and boxes.

**Protective Cover:** Also called a dust cap, the protective cover prevents damage to the front-end of a connector when the interconnect is unmated.

**Stowage Receptacle:** Accessory device used as an attachment point on a box or wall for cable plugs or dust caps when in the unmated condition.

**Style II:** Term used to refer to a backshell with a stepped design that accommodates a large cable entry on the back end of a backshell and a small coupling nut on the front.

**Shield Termination:** EMI/RFI backshells are specified when individual wires or overall cables are equipped with braided EMI/RFI shielding. The shielding is terminated (attached) to the backshell using various means in order to create a ground path for any EMI that has bonded to the cable shield.

**Strain-Relief:** Connector accessory, typically a cable clamp, used to prevent wire conductors from being pulled out of the connector during use.

**Shell Size:** Numeric code used in backshell part number development used to indicate both the size of the backshell and the size of the connector it attaches to. Careful attention is required as the number size of the backshell and the connector are not always the same (for example in the case of D38999 connectors that use alphabetic shell sizes).

**Shrink Boot Adapter:** A type of rear-end connector accessory used for the attachment of shrink boots for strain-relief and environmental sealing.

**Tag-Ring:** Type of EMI/RFI backshell particularly well suited for the termination of individual wire shields.

## Backshell-to-Connector Coupling

Glenair offers four different coupling styles to meet every application requirement:

### Direct Coupling



Direct couplers thread directly onto the connector by rotating the entire part. A separate toothed follower provides backshell-to-connector grounding.

### Rotatable Coupling

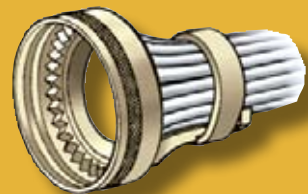

Rotatable designs utilize a free-spinning, toothed coupling nut for easier installation.

### Self-Locking, Rotatable Coupling



Rotatable Self-Lockers add a ratcheted detent "clicker" to prevent de-coupling due to extreme vibration and shock.

### Positive-Lock, Non-Detent Coupling



Glenair Mod Code -445 ("NESTOR") coupling mechanism corresponds to AS85049 style "N" non-detent, rotatable coupling with spring-loaded interface.

## Backshell Selection Guide

The design and development of today's broad range of connector accessories took over 50 years to complete, and the number of types and styles is truly extraordinary. Glenair's Circular Connector Accessories catalog, for example, presents 24 different categories of backshells and other accessories. The D-Subminiature portion of our new Rectangular Accessories catalog features over 30 different styles of backshells for use with popular rack and panel connectors. Glenair also produces dozens of different composite and fiber-optic backshell designs, not to mention thousands of Mil-Spec configurations. Perhaps the most revealing figure is the 70,000 part numbers—mostly connector accessories—now available in our Same-Day Inventory. The staggering number of backshell types available today makes it all the more important for interconnect engineers, and others tasked with the responsibility of specifying connector accessories, to become expert at the art of backshell selection. Here are the basics:

### Step One: Determine Accessory Functionality and Performance Requirements

The first step in successful backshell selection is proper product application: In other words, what exactly is the accessory supposed to do, and what are the conditions in which it must accomplish its job? It's not enough, for example, to know that the accessory must provide strain-relief. It's critical to also understand the working environment—the high heat of an engine compartment, for example—before moving forward in the selection process. And the more complex the application, the more detailed the questions need to become, lest some important functionality or performance requirement be forgotten.

The following questions will reveal the most critical functional and performance requirements for the accessory, and help a knowledgeable engineer make the best design, material and plating selections:

**(1) What is the intended working environment of the interconnect system—shipboard, space, airframe, ground support and so on?**

**(2) What level of environmental protection is required—full water immersion, moisture resistance, chemical/caustic fluid resistance, extreme corrosion resistance, mud?**

**(3) What level of electromagnetic shielding is required—overall cable shielding, individual conductor or both? Is any particular style of shield termination required in the target assembly?**

**(4) What level or amount of strain-relief, from light duty to gorilla proof, is required to protect shield and conductor terminations from damage?**

**(5) What is the temperature range of the application environment? Is it so hot that stainless steel is called for, or is it so cold that a special elastomeric seal should be specified?**

**(6) Is reparability a design requirement? Some split shell designs make field repair a snap, while some solid shell models make repair and maintenance extremely difficult.**

**(7) Are there size or shape constraints which need to be considered? Is working room so important, for example, that a long extender should be designed in? Or is available space so tight that a low profile design is called for? Does cable routing dictate 45°, 90° or straight cable entries?**

**(8) Is a metal shell required or is composite thermoplastic an option? Is saving weight so critical, in other words, that only composite backshells need apply? Or is metal preferred due to cost, strength or design approvals?**

**(9) And speaking of approvals, does the application require performance per AS85049 or another commercial, military or industrial performance specification?**

### Step Two: Determine Connector Part Number and Interface Designator

By 1970, Mil-Spec connector documentation controlled the interface mateability of plug to receptacle for all the major circular connector families—MIL-DTL-5015, MIL-DTL-28840, MIL-DTL-38999 and so on. Which meant that no matter who manufactured the connectors they would, at least in theory, intermate with the same family of parts from any other manufacturer.

Shortly thereafter, rear connector-to-accessory

## Cable Sealing Backshells Submersible Backshells

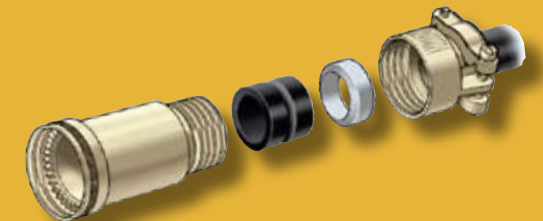

This Cable Sealing Backshell offers immersion protection to 6 ft. when used with impervious jacketed cables. A resilient grommet which fits into a counterbore in the backshell compresses and seals against the cable jacket when the threaded strain relief is tightened.

### Water-Tight Backshells

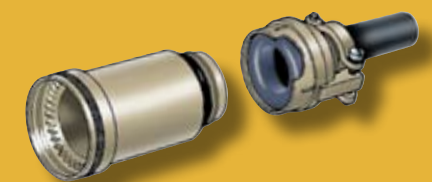

This Cable Sealing Backshell provides a resilient grommet, that prevents water incursion up to 3 ft., as an integral part of the cable strain relief.

### Splash-Proof Backshells

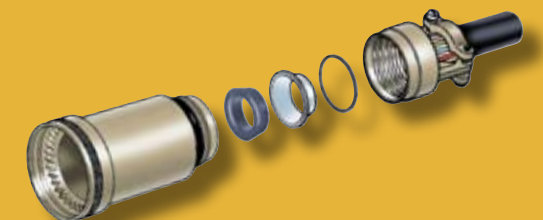

For moisture resistance and sealing against dust only, Glenair offers Environmental Resisting Backshells. An effective sealing barrier is created by a resilient grommet at the backshell cable entry.

### Environmental Shrink-Boots



For use with series 311, 319 and 440 type backshells, Glenair "Full Nelson" Shrink Boots provide dependable sealing of cable assemblies.

## Strain-Reliefs

Typical Mil/Aero cable assemblies often have over a hundred wires terminated to a single connector. Preventing the wires from pulling on the contacts and damaging the termination is critical, and is usually accomplished with a strain-relief clamp or shrink-boot that isolates the pulling strain applied to the cable. Strain relief on electrical connectors can be accomplished in other ways, such as with a wire service loop that allows the wire to move between the clamping device and the contact without overstressing the termination. But the basic method of clamping the wire bundle or cable jacket with saddle bars is the most common method of protecting contact terminations.

• **Straight and Angled Strain Reliefs**

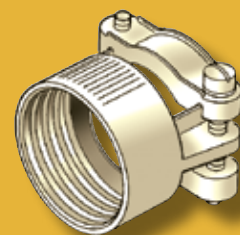
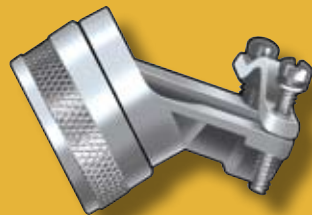

• **Light, Medium and Heavy-Duty Saddle Bars**

• **Qwik-Ty®**

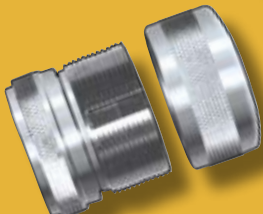
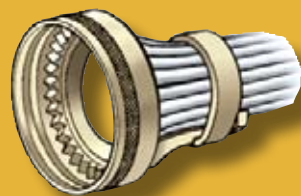

• **QwikClamp®**

• **Series 77 "Full Nelson" Shrink-Boots**



interface geometries were also standardized and came under the control of a number of military specifications, principally MIL-C-85049. This meant it was no longer necessary for accessory makers to consider both the connector type, shell size as well as manufacturer in order to correctly mate their accessories to a given family of connectors.

Today, interconnect system designers simply need to identify the correct part number for the chosen connector and match it to an alphabetic interface designator to select accessories which correctly fit the part. Tables listing all the major connector-to-accessory interface designators used by Glenair can be found in the Backshell Interface Standards table in the general information section of the Circular Connector Accessories catalog.

While the interface designators take much of the guess work out of the process, it is still important to evaluate the chosen connector in terms of application performance requirements. And if necessary, to work with Glenair engineering to suggest an alternative connector for the application.

### Step Three: Determine Cable Make-up

Several key questions in backshell selection cannot be answered without a solid understanding of the overall make-up of the cable and harness on which the accessory will be used. Basic dimensional elements, for example the diameter of the backshell cable entry, cannot be specified without accurate OD measurements of the cable or wire bundle in hand.

As mentioned, the make-up of the cable and the selection of strain-relief, environmental protection or shield termination technologies go hand-in-hand. At the risk of waxing pedantic, it has been our experience that significant problems, such as an unanticipated susceptibility to EMI in the electronic equipment serviced by the cable, are much less costly to resolve when tackled at this stage of the design process. Imagine the difficulty of re-engineering a printed circuit board or a re-building a complex interconnect cable because you failed to optimize cable shielding and grounding back when it was easier to accomplish.

Many EMI filter connector customers, for example, find themselves in this situation after

finished systems fail to pass required EMC testing. Making sure the cable fits through the backshell is a basic but important task. Making sure the right EMI shield termination and grounding technologies get designed into the system is perhaps even more important, but it is all too often an overlooked step in the process.

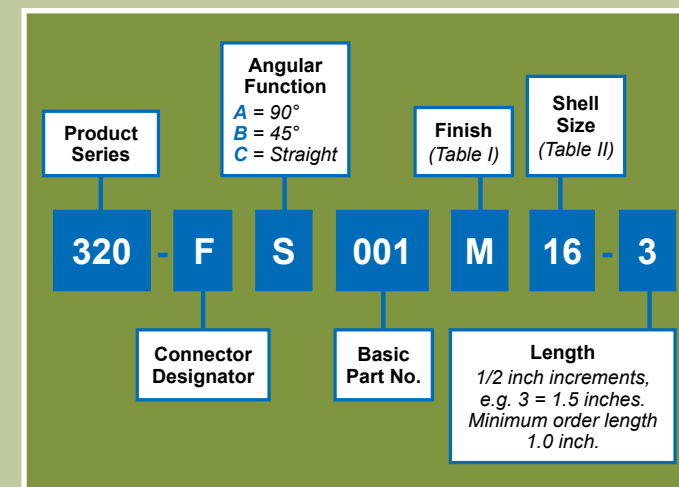

### Step Four: Develop Accessory Part Number

Glenair follows a standardized format for the development of accessory part numbers, so mastering the process once will enable you to build valid part numbers from any accessory product family—circular, rectangular, composite, shipboard, fiber optic, and so on. Some differences are of course to be found from one product series to the next because of the range of available options. But the following steps should serve as general enough guide to the process for most accessories:

- Select the Product Series:** do you want a dust cap, a banding adapter, an environmental backshell or a Qwik-Ty? Use the product selection guide in each catalog to find the right numbered product series. Mil-Spec connector accessories use slash-sheet nomenclature, but are cross-referenced in every catalog to the Glenair product series.
- Select the Connector Designator:** as described above, this alphabetic designator is used to match each connector family with the correct backshell interface dimensions.
- Select the Angular Function:** Straight, 45° or 90° (See Sidebar).

## Angle and Profile

The art of successful backshell selection includes specifying the most appropriate shape and cable entry for each connector accessory.

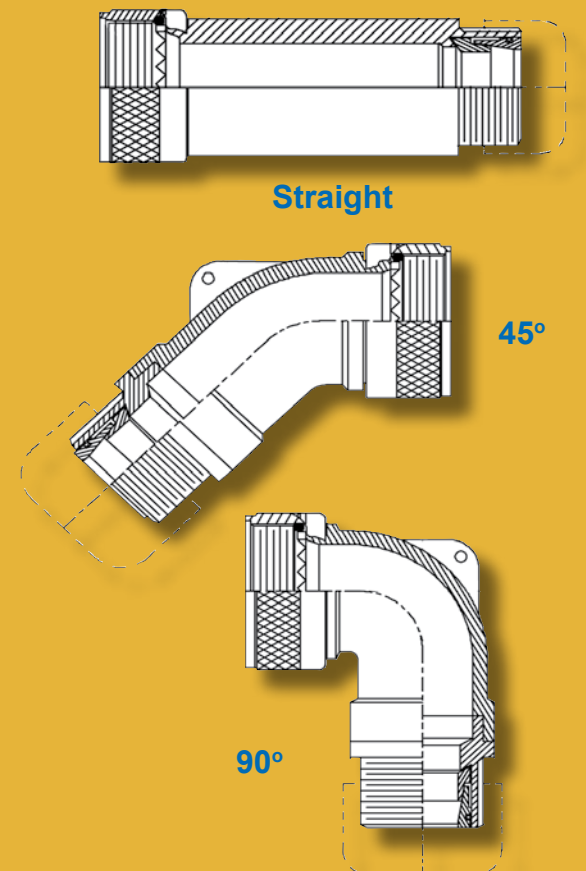

This selection can affect working room, reparability, cable routing and overall package size. In addition to straight backshells, the range of angles and profiles offered by Glenair include:

- 45° Elbow - Standard Profile (H)
- 45° Elbow - Low Profile (B)
- 45° Elbow - Full Radius Profile (M)
- 45° Elbow - Low Profile Split Shell (F)
- 90° Elbow - Standard Profile (J)
- 90° Elbow - Low Profile (A)
- 90° Elbow - Full Radius Profile (N)
- 90° Elbow - Low Profile Split Shell (D)
- 90° Elbow - Ultra Low Profile Split Shell "Cobra" (C)

**(4) Select the Basic Part Code:** This code fine-tunes your selection within the product series. For example, for Series 39 EMI/RFI Cable Sealing Backshells, your Basic Part Code selection could tell the factory what style of shield termination technology you prefer.

**(5) Select the Finish Symbol:** This symbol, selected from tables right there on the catalog page, or in some cases from a larger table elsewhere in the book, tells the factory what surface finish or plating should be applied to the product.

**(6) Select the Shell Size:** This of course is simply the matching of the accessory shell size to that of the chosen connector. Use the Backshell Interface Dimensions table found in the catalogs to find the part number code for your choice.

**(7) Select the Cable Diameter:** Referred to most commonly as just the “dash number” this piece of the part number specifies the minimum and maximum size of cable the rear end of the accessory can accept. Dash number selection tables are generally found right there on the page or on an immediately adjacent page.

**(8) Select the Strain Relief Style:** Most accessories that are able to accept cable clamps or saddle bars offer a range of style choices. The selection is usually based on the level or duty of strain-relief that is required, and design drawings of applicable options are featured right there on the catalog page.

**(9) Select the Environmental Sealing:** When different levels of environmental sealing are available, the choices are presented right there on the page. Full immersion protection is accomplished by capturing the cable grommet and follower within a cylindrical socket. Moisture proof designs merely force the cable grommet seal against a conical ferrule.

**(10) Select Unique Options:** Other available options, such as drain holes, wire attachment lengths, special material designators, and so on, are tacked on to the end of the part number. These options are generally explained right there on the page.



### EMI/RFI Backshell Designs

**Glenair TAG® Ring Backshells**



Glenair TAG® Ring Backshells offer a unique and reliable method of terminating individual wire shields.

**Raychem Tinel-Lock® Terminators**

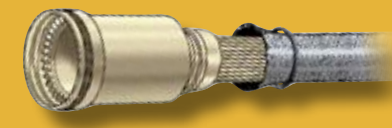

Glenair offers the Raychem Tinel-Lock® termination method. Applied heat causes the alloy ring to contract, clamping the shield to the backshell.

**Band-It® Termination System**



The unique low profile and smooth inside diameter of the Band-It® steel clamping band virtually eliminates EMI leakage paths, providing reliable and repairable shield terminations.

**Crimp Ring Termination System**

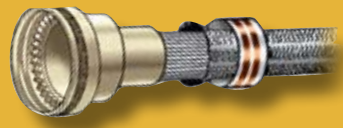

Crimp ring terminations provide an efficient approach to terminating overall cable and harness screens. Individually sized bands are required for each adapter and shield combination.

**Conical Ring Style Backshells**



Glenair EMI/RFI conical ring backshells provide reliable individual and overall shield termination by securing the shield under pressure between a conically shaped backshell and ground ring.

## EMI Shield Termination Devices

Selecting the most appropriate shield terminating backshell for a particular application requires a detailed analysis of the cable and the application environment in which the assembly will be used. There is no single shield termination technology or methodology that will meet every customer requirement. For this reason, Glenair supports every popular shield termination method with the full range of shell sizes, materials, platings and tooling, including:

- Single and Multiple Conical Rings
- Crimp Rings
- Banding Terminations
- Castellated or Splined Rings
- Lamp base Thread Rings
- Radial Compression Springs
- Integrated Shield Socks
- Magnaforming
- Tinel™ Lock-Rings

Customer selection depends on many factors, including cost and ease-of-use, but the primary factor is cable construction: what type of shield is being terminated, where the shield or combination of shields is located within the cable or wire bundle, and how difficult the outer jacket is to work with. Customer preference, established methods and practices, tradition, manual skill levels and inspection procedures must also be considered.

The relative effectiveness of each style can be measured using a transfer impedance test. The transfer impedance test is the most widely accepted absolute measure of a shield's performance. It is used to evaluate cable shield performance against electrostatic discharge and radiated emissions coupling at frequency ranges up to 1 GHz. This testing method is recommended by the International Electrotechnical Commission as well as the military. Test reports for most standard termination technologies are available upon request from the factory.

## Corrosion Protection and EMI

Glenair has a responsibility to deliver interconnect systems and hardware to its customers without “built-in” corrosion problems. As part of this effort we have pioneered the use of corrosion-free composite thermoplastic materials. Composite materials should be considered for all harsh application environments.

The problems associated with corrosion are compounded by the need to produce parts which are electrically conductive. To prevent EMI from permeating into system electronics, conductive cable shielding is grounded to plated backshells and connectors to take the unwelcome EMI to earth. The challenge is to produce conductive, plated products which both prevent EMI and resist corrosion in harsh application environments. At Glenair this work takes place in three areas:

1. Dissimilar metal avoidance;
2. Specification of stainless steel and composites; and
3. Surface coatings to isolate base metals from reactive electrolytes.

The selection of compatible (non-galvanic) surface finishes is a critical step in backshell specification. To prevent dissimilar metal corrosion, customers should note material and finish specifications for connectors and cable shields before selecting connector accessory hardware. As a general rule, the backshell material and finish should match that of the chosen connector.

Electroless nickel plating (code M) provides a low resistance conductive finish appropriate for most H (magnetic) and E (electrical) field EMI applications, and is ideally suited for benign environments not exposed to salt-spray. For environmental applications, a sacrificial plating, such as cadmium plate over electroless nickel (code NF), is recommended. Glenair zinc-nickel over electroless nickel (code ZN) may also be specified for environmental applications which require ASTMB 841-91 approval but are prohibited from using cadmium. Non-EMI applications may utilize nonconductive finishes such as Black Anodize (Code C).



# Seven Innovations From the Space Race that led to Products We Use Everyday!

## 1. Smoke Detectors From Space!

Smoke detector technology was originally developed for the Skylab space station to warn crew members of toxic gas accumulation. Now, these “smoke detectors from space” eerily reminiscent of flying saucers, are routinely used by amateur film makers (in tin-foil hats) to create phony images of UFO’s and frightening alien invasions.



## 2. New Help for Obsessive Compulsive Scientists



Foggy goggles can be hazardous, especially when mixing caustic chemicals! But thanks to NASA—which developed an anti-fogging solution to keep spacecraft windows cloudless during takeoff and reentry—even the most obsessive compulsive scientist on Earth can now work for hours on end in attractive, non-fogging goggles. Just imagine the worry-free hours they’ll enjoy uninterrupted by the maddening desire to wipe away annoying condensation.

## 3. Infrared Technology Bolsters Health Care

When NASA created its innovative infrared-sensing thermometers for use in detecting elusive heat signatures in space, who would have guessed the technology would help bolster health care cost-cutting efforts! Now incorporated in patient-friendly ear-thermometers—that even the youngest toddlers can use—the infrared technology will save countless health-care dollars as patients learn to self-diagnose and treat ailments without the help of costly medical “professionals.”



## 4. Rock On!

Guitars are now made with the same super-resilient composites used in the Space Shuttle. The lightweight material reportedly emits sound 11 times faster than wood, which is, like, way faster than 10.

## 5. Credit Card Denied? Thank NASA!

Did you know that NASA had to create specialized software to manage its multiple onboard space vehicle systems? And did you also know that this same program, by virtue of its ability to recognize and identify data from multiple sources, is the software behind today’s credit card authorization system?



## 6. QwikClamp Calms Space Station Astronauts

The QwikClamp Backshell, a Glenair innovation, provides cable and wire strain-relief on the International Space Station. The sharp screws on standard cable clamps can potentially cut an astronaut’s space suit—a hair-raising event indeed! But the QwikClamp has no sharp edges, bringing calm and serenity to space travel, and perhaps someday, to a cable near you.



## 7. Astronauts Deface Moon with Cordless Power Drill!

Tool maker Black & Decker was commissioned by NASA to produce battery-powered instruments to aid in the collection of lunar samples by Apollo astronauts. Now, cordless technology is commonplace throughout the home—from the backyard to the bedroom!



## New Glenair Backshell and Connector Accessory Innovations

### Composite Swing-Arm with Keyed Banding Insert



This version of the popular Swing-Arm Strain-Relief Clamp features a banding insert that makes termination of EMI shielding a snap! In assembly, the strain-relief portion of the clamp is run-up and staged out of the way on the cable. This allows the user to complete the termination of the braided shielding to the special insert banding device with relative ease—unconstrained by the limited working-room usually afforded by combined strain-relief/shield termination devices. The toothed insert device and the clamp are then drawn together and the assembly is threaded to the connector, creating a tight, reliable ground path. See Series 627-142 in the Glenair *Composite Accessories* catalog for more information. Free sample available on request.

### StarShield “Zero Length” Individual Shield Termination Backshell

The Glenair Series 470-013 StarShield “Zero Length” Individual Shield Termination Backshell offers optimal grounding of EMI/EMP braided shielding. The unique StarShield configuration completely eliminates “standing antenna” problems common with pigtail shield termination systems. The backshell utilizes familiar solder sleeve technology for fast and reliable termination of shielding—even with dissimilar wire types and gauges. The internal configuration of the StarShield features a tapered split-ring that fits snugly into the conically machined backshell. Tightening the coupling nut in place effects 360° grounding of all conductive surfaces. Standard configurations of the StarShield Backshell include banding and shrink-boot versions. Free sample available on request.



### TAG-Ring/Qwik-Ty Feed-Through Fitting



Feed-through fittings are an important but often overlooked component in Glenair’s “No-Gaps” product line. Used for non-connectorized wire and cable routing, our feed-through fittings are available in metal and composite versions with a wide range of environmental, EMC and strain-relief features. The example shown is a Series 407-038 TAGRing® feed-through, perfect for individual wire shield termination. We offer similar feed-throughs with a banding platform, constant-force EMI shield spring, or a shrink-boot groove. Free sample available on request.

### Self-Locking, Anti-Decoupling Receptacle Protective Cover

Designed for higher-performance applications, these protective cover designs are equipped with anti-decoupling technology that ensure reliable performance under conditions of severe vibration and shock. For D38999 Series III in aluminum and stainless steel ask for series 667-024. For composite versions the basic part number is 667-117. For the same part for other connector series please consult the factory. Our 667-079 series protective cover also offers an anti-decoupling spring-loaded element in a lower-profile package. Free sample available on request.



### Spring-Loaded “Flop-Lid” Protective Cover



This innovative protective cover design may be configured for use on any jam-nut or box mount type cylindrical receptacle connector, including the Series 80 “Mighty Mouse”. The 667 series “Flop-Lid” cover provides excellent, gasket-sealed protection of connectors when in their un-mated condition. Equipped with a powerful spring, the “Flop-Lid” cover is poised to close immediately upon connector disengagement. The product is made from plated aluminum alloy. Spring and spring shaft are passivated stainless steel.

**GLENAIR**  
INNOVATIVE, PROBLEM SOLVING  
**PROTECTIVE COVERS**

**“To Protect and To Serve”**

Protective covers are a critical component in interconnect systems where maintenance cycles can lead to damage of exposed connectors. Glenair produces the widest range of protective cover solutions in the world—for every connector series, in every material including composite, metal and rubber. We also maintain the world’s largest standing inventory of mil-spec and commercial protective covers. For many part numbers, we can supply reasonably large quantities in just one day.

In addition to M85049 QPL protective covers, Glenair also manufactures many special purpose dust-caps with innovative features available only in our commercial series products—and only from Glenair!

<b>COMPOSITE</b>	<b>RUBBER</b>
	
<b>MIL-SPEC</b>	<b>COMMERCIAL</b>
	

**SERIES 77**

**FULL NELSON**

**Heat Shrink Boots**

*Outstanding Environmental and Mechanical Protection*

*"Think he'll ever break that hold? Nope. He's got him in a Full Nelson!"*



Shrink boots provide mechanical and environmental protection to connector-to-cable transitions. Specially formulated polymers are injection-molded, then heated and expanded. The shape-memory property of the material allows it to return to its original shape when heated with a hot air gun. Optional adhesive coatings on the inside of the boot provide a watertight, high-strength bond to the cable jacket and the connector or adapter. Glenair has just launched a major foray into the shrink-boot market with a comprehensive catalog of parts and materials. Most important, we are putting all our Series 77 products into stock for immediate same-day shipment.

**Series 80 "Mighty Mouse" Backshells**

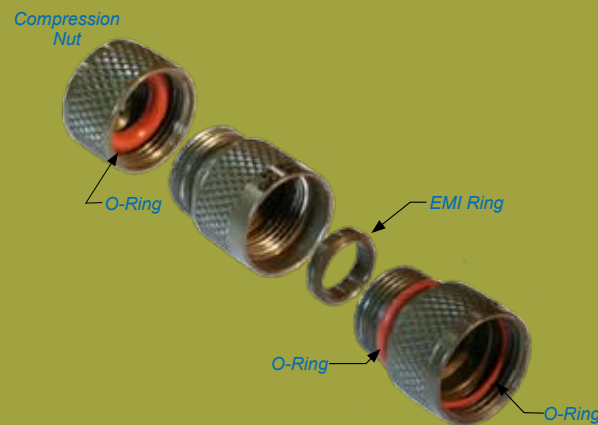

Glenair Series 80 "Mighty Mouse" connectors are now supported with an expanded range of both rear-end backshells and well as dustcaps, o-rings, flange gaskets, nut rings and more! The Glenair "no gaps" model has been applied to this popular ultra-miniature connector series and the result is a comprehensive range of accessory solutions for all standard requirements, including EMI shield termination, shrink-boot attachment, environmental sealing, strain-relief and so on.

**M85049/75 and Glenair Commercial Potting Boots**



Not exactly a new product, but there is so much confusion in the marketplace on where to get these items we thought we would give them a plug here. Available in straight and 90° configurations in plastic or aluminum, these simple rear-end accessories provide an easy and convenient receptacle for wire sealing potting material. Ask for Glenair series 307-037 thread-on metal potting boot rings or the M85049/75 plastic snap-on version.

**Split-Shell D-Sub Backshell with EMI/RFI Shield Termination and Strain-Relief**

This lightweight, composite backshell, designed for MIL-DTL-24308 connectors, features a unique internal shield termination zone with a ribbed profile that also provide additional strain-relief. The dimensionally stable composite part has been tooled for shell sizes 1 through 5 and can be supplied with the users choice of jackscrew hardware, plating and additional screws and screw bosses that enhance shield retention and grounding. Ask for series 557-477



**557-518 Series Composite "Snap-D" Backshell for MIL-DTL-24308**



Tell your friends you saw it here first. This backshell will become the new standard for interior, pressure-zone applications such as IFE. The plated, composite "Snap-D" has all the features you wish D-Sub backshells had offered long ago: Split-shell, snap-together packaging; hardwareless (no screws!) connector retention; fully-encapsulated (skirted) design; integrated bail-latch; lightweight strain-relief; *Band-It*® Band shield termination—overall and individual; internal, ribbed compression zone for additional strain-relief and improved EMC; and of course composite material performance: the lightest weight and the best corrosion resistance.

**Low-profile Composite EMI/RFI Swing-Arm Strain-Relief (and/or Shield Sock) Assembly**

The Glenair Swing-Arm Clamp and braid-equipped EMI/RFI Shield Sock version provide an alternative strain relief and shield termination solution for shielded, jacketed cable assemblies. Made from high-temperature composite thermoplastic, these compact, low-profile versions of the popular Swing-Arm series offer easy installation, long term durability, and outstanding weight and cost reduction. The products are equipped with reliable "click-style" self-locking rotatable coupling nuts. Available shielding materials include standard metal braid as well as light-weight metal clad composite shielding. The shield sock's braid is terminated directly to the cables own braid with *BAND-IT*® bands and tools.



**Series 437-001 Backshell "Connector Saver"**



This special backshell can be the perfect solution to a very expensive wiring mistake or connector gender problem. In use, a pair of receptacle connectors are mated to the backshell coupling nuts at either end of the assembly, wired back-to-back and then buttoned up tight inside the split shell housing. This double-ended backshell allows users to easily rectify mis-wired cable or change the gender of deliverable connectors in a complex interconnect system. The split shell feature allows for easy assembly of the device as well as re-entry for future maintenance.

# Glenair Backshell Plating Code and Mil-Spec Connector Finish Code Cross-Reference

MIL-DTL-38999 Series I and II Finish Code	Material, Finish	Recommended Glenair Accessory Code
A	Aluminum, Cadmium Plated, Clear Chromate	LF
B	Aluminum, Cadmium Plated, Olive Drab	NF
C	Aluminum, Anodize, Hardcoat	G
E	Stainless Steel, Passivated	Z1
F	Aluminum, Electroless Nickel Plated	M
N	Stainless Steel, Electrodeposited Nickel (Hermetic)	ZL
P	Aluminum, Pure Dense Aluminum (AlumiPlate <sup>SM</sup> )	AL
R	Aluminum, Electroless Nickel	ME
T	Aluminum, Nickel-PTFE	MT
U	Aluminum, Cadmium Plated, Clear Chromate	LF
X	Aluminum, Cadmium Plated, Olive Drab	NF
Z	Aluminum, Zinc-Nickel, Black	ZR

MIL-DTL-38999 Series III and IV Class Code	Material, Finish	Recommended Glenair Accessory Code
C	Aluminum, Anodize, Hardcoat	G
F	Aluminum, Electroless Nickel	M
G	Aluminum, Electroless Nickel	M
H	Stainless Steel, Passivated	Z1
J	Composite, Cadmium Plated, Olive Drab	XW
K	Stainless Steel, Passivated	Z1
L	Stainless Steel, Electrodeposited Nickel	ZL
M	Composite, Electroless Nickel Plated	XM
N	Stainless Steel, Electrodeposited Nickel (Hermetic)	ZL
P	Aluminum, Pure Dense Aluminum (AlumiPlate <sup>SM</sup> )	AL
R	Aluminum, Electroless Nickel	ME
S	Stainless Steel, Electrodeposited Nickel	ZL
T	Aluminum, Nickel-PTFE	MT
W	Aluminum, Cadmium Plated, Olive Drab	NF
X	Aluminum, Cadmium Plated, Olive Drab	NF
Y	Stainless Steel, Passivated	Z1
Z	Aluminum, Zinc-Nickel, Black	ZR

MIL-DTL-83513 Finish Code	Material, Finish	Recommended Glenair Accessory Code
A	Aluminum, Pure Dense Aluminum (AlumiPlate <sup>SM</sup> )	AL
C	Aluminum, Cadmium Plated, Gold Chromate	JF
K	Aluminum, Zinc-Nickel, Olive Drab	ZN
N	Electroless Nickel	M
P	Stainless Steel, Passivated	Z1
T	Aluminum, Nickel-PTFE	MT

MIL-DTL-5015 Class Code	Material, Finish	Recommended Glenair Accessory Code
A, B, C, E, F, P, R, W	Aluminum, Cadmium Plated, Olive Drab	NF

MIL-DTL-26482 Series I Series 2 Class L Series 2 Class W	Material, Finish	Recommended Glenair Accessory Code
Series I	Aluminum, Cadmium Plated, Olive Drab	NF
Series 2 Class L	Electroless Nickel	M
Series 2 Class W	Aluminum, Cadmium Plated, Olive Drab	NF

AS85049 Finish Code	Material, Finish	Recommended Glenair Accessory Code
A	Aluminum, Black Anodize	C
B	Stainless Steel, Cadmium Plated, Black	ZU
G	Aluminum, Electroless Nickel Plated (Space)	M
J	Composite, Cadmium Plated, Olive Drab	XW
L	Composite, Cadmium Plated, Olive Drab <sup>(1)</sup>	XX
M	Composite, Electroless Nickel Plated	XM
N	Aluminum, Electroless Nickel Plated	M
P	Aluminum, Cadmium Plated, Olive Drab <sup>(1)</sup>	NFP
W	Aluminum, Cadmium Plated, Olive Drab	NF
T	Composite, Unplated	XO

(1) Selective plated with polysulfide barrier

# Toolin' Around Glenair...

Glenair is *the* connector accessory and EMI shield termination tool-maker for the interconnect industry. Here is an overview of the tools we produce that make backshell-to-connector assembly a breeze!

Nobody can grasp the ins-and-outs of interconnect tool design and manufacturing without a full understanding of cable harness assembly. At Glenair, we not only manufacture the connectors, backshells, cables and enclosures which go into interconnect cable systems, we run a top-flight cable assembly service of our own. And we've drawn on this extensive experience to design and build a complete family of specialized backshell assembly tools for most Mil-Standard circular connectors, as well as connector wrenches, mini-strap wrenches, universal connector holding tools and braid termination tools for production use and field maintenance.

Glenair's selection of circular backshell assembly wrenches include round wrenches in all standard sizes that are designed to be employed with Glenair's hand-held or bench-mounted torque wrenches. The round design assures even distribution of pressure around the backshell, thereby preventing false tightening and distortion problems. A hex design for Glenair composite coupling applications is also offered. Strap wrenches, soft-jaw pliers and connector wrenches for a full range of connector-to-backshell assembly applications are available.

The backshell tightening tools which make up our core tool offering provide a full 360° gripping surface on the backshell coupling nuts. These essential tools minimize the possibility of coupling nut distortion and false tightening problems which can be caused by soft-jaw pliers or strap wrenches. For composite backshell coupling nuts it is essential to use only our 600-091 (aluminum) or 600-157 (stainless steel) series tools and to tighten the coupling nut to the prescribed torque values. When used with the appropriate connector holder and a torque, our backshell assembly tools provide the user with reliable and repeatable assembly performance.

Glenair offers a variety of tools to accomplish proper tightening. Our 600 Series pliers with replaceable pads are configured to make maximum circumferential support to each specific size backshell to be tightened, and our TG70 strap wrench is intended for general use on any diameter between .50 to 3.00 inches. Hand-held and bench-mount torque wrenches accommodate our 600-005 plug or receptacle connector holders.

When tightening a backshell onto a connector, it is important to follow Glenair's recommended procedures for each tool. Our Backshell Assembly Tools, Banding Tools and Accessories catalog shows torque values for each specific connector series the backshell is being fastened onto. The recommended values are based on several factors, primarily the connector and backshell thread strengths. Torque values consider additional factors such as plug-to-receptacle alignment key strength, barrel hoop strength and the material strength of the coupling nut.

When tightening backshells with rotatable coupling nuts, Glenair recommends the backshell be hand tightened to engage the connector's interlocking teeth or spline features, making sure the teeth are fully engaged before fully torquing with our tools.

We also suggest re torquing by removing the tool and reinstalling the tool approximately 90° away from the initial position and tightening to the recommended value. When applying torque with our TG70 strap wrench, it is necessary to allow for a slight torque variance between the Glenair torque wrench and the offset socket drive on the strap wrench.

The *BAND-IT*® clamping system provides quick and highly reliable termination of braided metallic shielding or fabric braid. Banding technology was first introduced in our industry in 1985 as a solution to the field repair of magnaformed shield terminations on installed cable assemblies for the B-1 bomber. Banding has been a staple of the industry ever since.



COMPOSITE COUPLING TORQUE VALUES	
Shell Size Reference	Composite Torque (Inch-Pounds)
08/09	35
10/11	35
12/13	40
14/15	40
16/17	40
18/19	40
20/21	80
22/23	80
24/25	80
28	120
32	120
36	120

# Glenair Connector Accessory Manufacturing Process Guided Tour

Glenair's manufacturing capability is unique in the interconnect industry. Carefully planned vertical integration gives us unparalleled control over the most important parts of every manufacturing process. From machining of raw bar stock to plating of connector accessory shells, Glenair performs the work.



**P**rimarily manufacturing processes convert raw materials into a useful form and shape that typically requires additional operations and processes for completion. Machining is a generic term for removing material from a work piece to form a useful shape. This material removal can be accomplished by rotating the cutting tool as it bites into a stationary work piece, or by rotating a work piece and moving it into a stationary cutting tool. The most common machining centers are lathes and mills.

**R**od (or round bar) is used for circular shapes such as connector and backshell bodies, coupling nuts, and protective covers. Tube is commonly used for rings and ferrules. Hex bar is a good source for jam nuts. Square bar is used to produce flanged connector bodies and dummy stowage receptacles.



**T**he vast majority of our machined aluminum is Alloy 6061. With its excellent anti-corrosion properties, good acceptance of applied coatings, ability to accept welds and brazing, and light weight relative to other metals, it's ideal for many components used in interconnect systems. We also use large quantities of 300 series corrosion resistant steel which, with passivation, can withstand up to 2000 hours salt spray, making it one of the most resilient materials available for high-reliability connectors and accessories.



**W**e should also note that many of our parts are made from engineering thermoplastics. Ultem 2300 is an extruded 30% glass reinforced polyetherimide. It's a high-performance polymer with exceptional flame and heat resistance, making it ideal for high strength/high heat applications, and those requiring consistent dielectric properties over a wide frequency range. It is hydrolysis resistant and highly resistant to acidic solutions. Ultem provides excellent rigidity and dimensional stability.

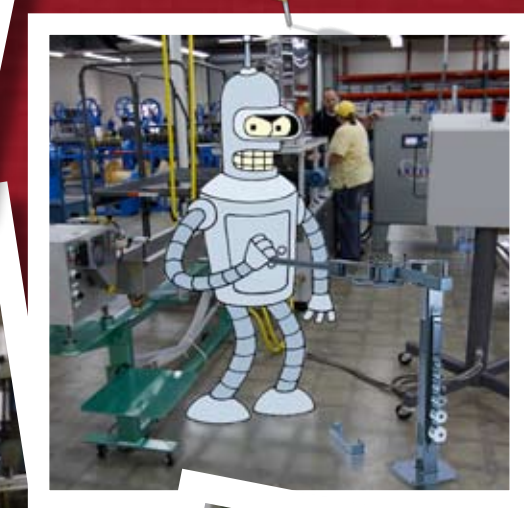

**R**otary Arm Tube bending is an accurate, high speed method of tube bending. This versatile method can work with or without a mandrel. A mandrel is a tool used to support the inside of the tube to improve the quality of the bend by minimizing any flattening which helps to control wrinkling during the bending cycle.



**M**any connector accessory components are produced via a process called die-casting, a four step process. First, the mold is sprayed with lubricant and closed. The lubricant both helps control the temperature of the die and also assists in the removal of the casting. Molten metal is then shot into the die under high pressure. Once the die is filled the pressure is maintained until the casting has solidified. Next, the die is opened and the shot is ejected by the ejector pins. Finally, the scrap, which includes the gate, runners, sprues and flash, must be separated from the casting(s).

**S**tamping is a metalworking method that includes punching, coining, bending and other ways to modify metal, combined with an automatic feeding system. The feeding system pushes a strip of coiled metal, often flattened large-gage wire, through all of the stations of a progressive stamping die. Each station performs one or more operations until a finished part is made. The final station is a cutoff operation, which separates the finished part from the carrying web.

**T**ransfer molding, like compression molding, is a process where the amount of molding material (usually a thermoset plastic) is measured and inserted before the molding takes place. Molding material is preheated and loaded into a chamber known as the pot. A plunger is then used to force the material from the pot through channels known as a sprue and runner system into the mold cavities. The mold remains closed as the material is inserted and is opened to release the part from the sprue and runner. The mold walls are heated to a temperature above the melting point of the mold material; this allows a faster flow of material through the cavities. The mold remains closed until the curing reaction within the material is complete. Ejector pins are usually incorporated into the design of the molding tool and are used to push the part from the mold once it has hardened. Many Glenair seals, grommets and glands are made in our transfer molding machines.



**A**ssembly, like all critical steps in the backshell manufacturing process is completed in-house at Glenair. When all the component elements of a job are plated and marked, they immediately make their way to assembly floors located adjacent to our main production facilities. This arrangement improves quality, and delivery times, compared to production models that place engineering, production and assembly resources in separate locations—sometimes half-way around the globe!

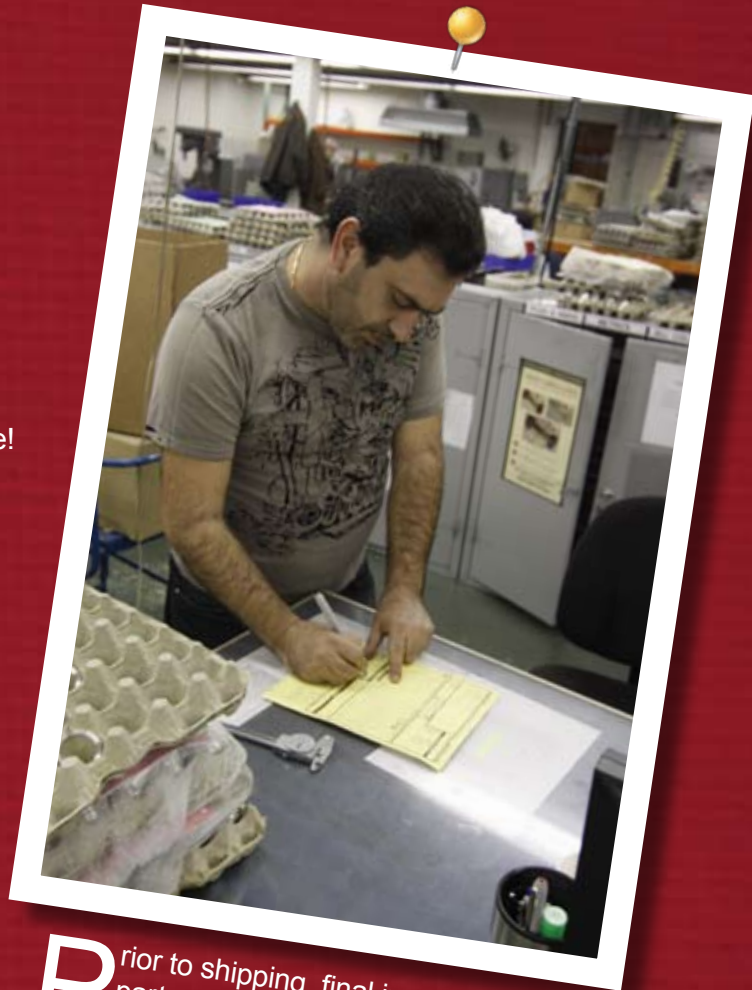

**P**rior to shipping, final inspection assures the right parts are being shipped, the latest drawing revision was used, customer specifications are met, packing meets customer requirements, and that certificates of conformance are enclosed.

**A**lmost every metal and thermoplastic part requires a finish treatment. Through electrical or chemical processes, metals or chemicals are deposited on part surfaces to provide conductivity, corrosion protection and coloration.

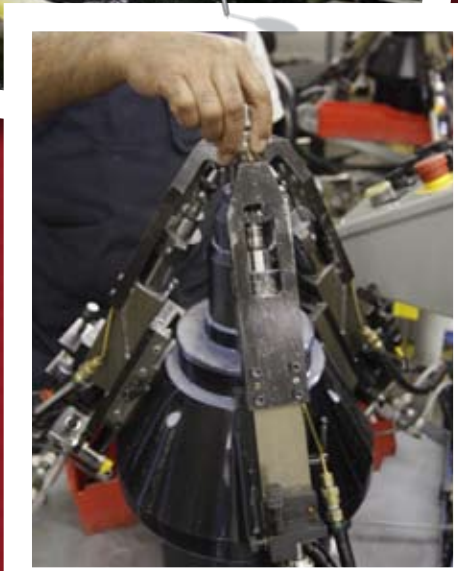

**M**il-Specs and other specifications call for permanent part number marking on every part sold by Glenair. One of the most efficient ways to produce this marking is the VideoJet that sprays on ink using a dot-matrix. Part numbering can include a Mil-Spec number, the Glenair cross reference number, the CAGE code and the manufacturing date code.

**M**any of Glenair's backshells and coupling nuts require secondary operations such as precision-drilled wire holes. The Glenair-designed "Rocket," drills all needed holes simultaneously. Other secondary operations include the removal of rough or sharp edges, the attachment or "crunching" of coupling nuts, and so on.



**G**lenair employs a unique "high-availability" business model designed to reduce lead-times on interconnect components. So, whenever we complete a production order on a popular part number, we "piggy-back" a quantity for stock.

**T**he cutting and welding of backshells is accomplished to create 45° and 90° parts that have not yet been tooled for high-production die-casting. In the welding process, molten filler metal is introduced along a seam to join two or more pieces. A number of Glenair components require welding, such as certain topside fittings for our metal core conduit wire protection systems.

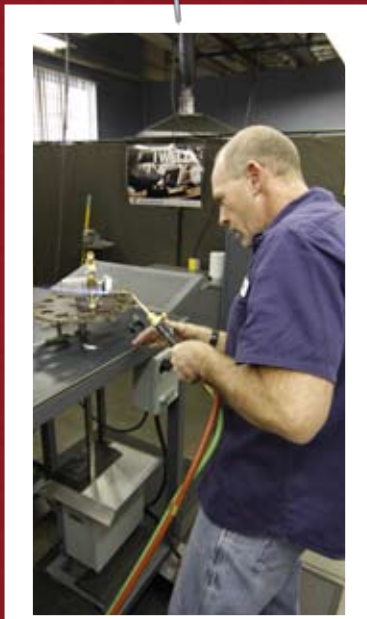

# Innovation and Availability: The Glenair Connector Accessory Product Line

*The Largest and Most Diverse Selection of Cylindrical and Rectangular Connector Accessories in the World!*

**G**lenair has the manufacturing capacity, raw materials, skilled operators, and necessary approvals to produce every military-standard and commercial connector accessory in use today. Tens of thousands of stock parts are staged for immediate, same-day shipment. Free samples are available upon request.





## How Not To Succeed

There is a humorous story of a rustic who said, "I wish I knew where I was going to die, and then I'd never go there." You may laugh, but in fact this fellow was on to something. Many clever people use the practice of "inversion" (looking at things from back to front) to gain a better understanding of difficult subjects. The mathematician Jacobi always counseled his students to "invert, always invert" when faced with a difficult piece of algebra.

I first came across this "inversion" approach in a speech Charlie Munger delivered in 1986 to the Harvard School here in Los Angeles. In his talk he explained that he was unable to tell the students how to be happy, but he had a sure-fire recipe they could follow if they wanted to be miserable. Charlie's recipe for misery in life went something like this:

First, be unreliable. Do not faithfully do what you have promised to do. Second, stubbornly learn everything you can in life from your own experience, minimizing at all times valuable opportunities to learn from the mistakes and successes of others. Third, when faced with a reversal in life, go down and stay down. Do not get back on that horse! And finally, never follow the advice of the rustic. Never bother to contemplate the places in life that will cause you harm and never avoid the behaviors that will surely take you there.

Successful businessmen are often asked by young people how to succeed in business. Better that they would ask how to fail. Answers like these might really open their eyes: Be unethical and untrustworthy; Put the customer at the bottom of your list of priorities; Remain inflexible when faced with changing business circumstances; Focus on driving cost out of your business rather than on improving customer service; Aggressively leverage and overextend your financial affairs; Adopt a short-term, rather than long term, business perspective.

I'm sure you can think of other "guaranteed prescriptions for business failure" to add to this list. But isn't it interesting how practical and direct the inversion method makes this discussion? By the way, when Munger concluded his talk to the students at Harvard School he gave them one last piece of sage advice, "gentlemen, may each of you rise by spending each day of a long life aiming low." I think in our business the equivalent advice would be: please spend every day ignoring your customers and never, ever deliver the level of quality and service you would wish to receive yourself.

Christopher J. Toomey  
President

### Publisher

Christopher J. Toomey

### Executive Editor

Marcus Kaufman

### Managing Editor

Carl Foote

### Deputy Editor

Alex Boone

### Art Director

Charles W. Belser

### Technical Consultant

Jim Donaldson

### Issue Contributors

Marv Borden

Greg Brown

Ty Geverink

Dave Glenn

Jim Plessas

Mike Wofford

### Distribution

Terry White

*QwikConnect* is published quarterly by Glenair, Inc. and printed in the U.S.A. All rights reserved. © Copyright 2009 Glenair, Inc. A complete archive of past issues of *QwikConnect* is available on the Internet at [www.glenair.com/qwikconnect](http://www.glenair.com/qwikconnect)

### GLENNAIR, INC.

1211 AIR WAY  
GLENDALE, CA 91201-2497  
TEL: 818-247-6000  
FAX: 818-500-9912  
E-MAIL: [sales@glenair.com](mailto:sales@glenair.com)  
[www.glenair.com](http://www.glenair.com)

