

# QwikConnect®

GLENAIR • JANUARY 2024 • VOLUME 28 • NUMBER 1

SPECIAL BUYERS GUIDE EDITION:  
RUGGED, MILITARY-GRADE

FIBER  
OPTIC  
INTERCONNECTS

**Glenair**®

New! PRIZM® MT  
Expanded-Beam

# FIBER OPTIC

## Interconnect Technology and Packaging

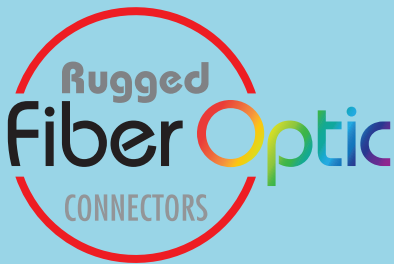

### Fiber Optic Operation

Today, the use of fiber optic systems to carry digitized video, voice, and data is universal. In military and defense, the need to deliver ever larger amounts of information at faster speeds with built-in redundancy is the impetus behind a wide range of retrofit and new fiber optic interconnect and datalink programs. The ruggedization of fiber optic interconnect systems enables the use of the technology in satellites, avionics, robotics, weapon systems, and flight-grade sensors.

Functionally, fiber optic interconnect systems are comparable to high-speed copper wire systems in their ability to carry high data rate transmissions. The principle difference is that fiber optics uses light pulses (photons) to transmit data across glass fiber lines, instead of electronic pulses to transmit data across copper. Other differences are best understood by taking a look at the flow of data from point to point in a fiber optic system.

The "encoding" side of an optical communication system is called the transmitter. This is the place of origin for all data entering the fiber optic data link. The transmitter essentially converts coded electrical signals into equivalently coded light pulses. A light-emitting diode (LED) or an injection-laser diode (ILD) is typically the source of the actual light pulses. Using a lens, the light pulses are funneled into the fiber optic connector (or terminus), and transmitted down the optical fiber.

Light pulses move easily across the fiber optic media due to the principle of "total internal reflection," which basically holds that whenever the angle of incidence exceeds a certain value, light will not emit through the reflective surface of the material but instead will bounce back in when the minimum bend radius of the F/O cable is respected. This principle makes it possible to transmit light pulses down a twisting, turning fiber without losing the light out the sides of the strand.

At the opposite end of the line, the light pulses are channelled into the "decoding" element in the system, known as the optical receiver or detector. Again, the actual fiber to detector connection is accomplished with a specialized fiber optic connector or terminus. The purpose of an



Complete fiber optic interconnect capability—from termini to optical media, connectors, cable assemblies, backshells and accessories, toolkits, training, and more—Glenair does it all.

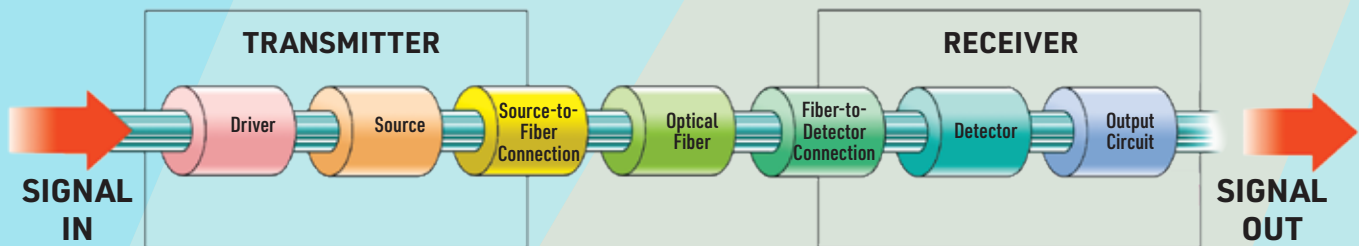

Basic Fiber Optic Link

optical receiver is to detect the received light incident on it and to convert it to an electrical signal containing the information impressed on the light at the transmitting end. The information is then ready for input into electronic-based devices, such as computers, navigation control systems, video monitors and so on.

## Cable Construction

There are typically five elements that make up the construction of a fiber optic cable: the optic core, optic cladding, buffer, strength member and jacket. The optic core is the light-carrying element at the center of the optical fiber. It is commonly made from a combination of highly purified silica and germania. Surrounding the core is the optic cladding made of pure silica. The combination of these materials makes the principle of total internal reflection possible, as the difference in materials creates a reflective surface at the point of interface. Light pulses entering the fiber core reflect off the interface between core and cladding, remaining within the core as they move down the line. Surrounding the cladding is a buffer material acting as a shock absorber to protect the core and cladding from damage. A strength member, typically Aramid, surrounds the buffer adding critical tensile strength to prevent damage from pull forces during installation. The outer jacket protects against abrasion and environmental damage. The type of jacket used also defines the cable's duty and flammability rating.

Rays of light passing through a fiber do not travel randomly. Rather, they are channeled into modes—the thousands of possible paths a light ray may take as it travels down the fiber. A fiber can support as few as one mode and as many as tens of thousands. The number is significant because it helps determine the fiber's bandwidth. Multimode fiber has a much larger core than singlemode fiber, allowing hundreds of rays of light to propagate through the fiber simultaneously. Singlemode fiber has a much smaller core, allowing only one mode of light to propagate through the core. Paradoxically, the higher the number of modes, the lower the bandwidth of the cable. The reason is dispersion. **Modal** dispersion is caused by the different path lengths followed by light rays as they bounce down the fiber (some rays follow a direct route down the middle of the fiber, and arrive at their destination before those rays which bounce back and forth against the sides). **Material** dispersion occurs when different wavelengths of light travel at different speeds. By reducing the number of possible modes, you reduce modal dispersion. By limiting the number of wavelengths of light, you reduce material dispersion.

Singlemode fibers are manufactured with the smallest core size (8–10 um in diameter) and eliminate modal dispersion by forcing the light pulses to follow a single, direct path. The bandwidth of a singlemode fiber is essentially infinite. Singlemode fiber is thus the preferred medium for long distance and high bandwidth applications.

Multimode fiber is chosen for applications where bandwidth requirements fall below 600 MHz. It is ideally suited for short distance applications such as datalinks used within an aircraft or other contained space. Multimode fiber is easier to polish and clean than singlemode, a critical concern in interconnect applications that expose the polished ends of the fibers to debris during connector mating and unmating.

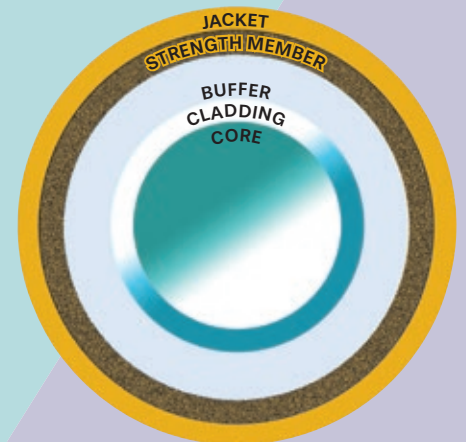

**FIBER OPTIC CABLE CROSS SECTION**

## ATTENUATION AND WAVELENGTH

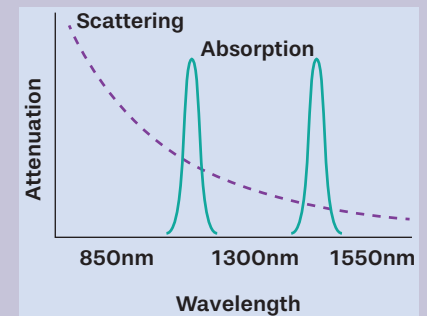

In optical fibers, attenuation refers to the loss of signal strength as light travels through the fiber. At 1550 nm, optical fibers exhibit lower attenuation compared to other common optical wavelengths such as 1310 nm. This means that signals at 1550 nm can travel longer distances in the fiber before experiencing significant signal loss.

## SINGLEMODE VS. MULTIMODE FIBER

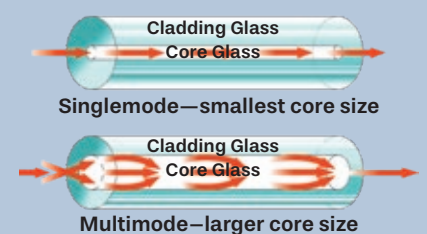

# FIBER OPTIC

## Interconnect Technology and Packaging

### Military Standards

The layout and configuration of a fiber optic interconnect system can vary widely based on the application environment. Commercial telecommunications systems, for example, typically feature extremely long backbone cables, spliced fiber interstices, and inexpensive ST type connectors at the many termination points in the system. The connectors used in such applications are typically commodity solutions geared to the low to moderate performance and reliability requirements of that industry. At the other end of the spectrum, fiber optics deployed in military avionics take the form of highly engineered interconnect harnesses and/or multi branch conduit systems. The ruggedized connectors used in these applications accommodate multiple fiber optic cables and typically utilize precision contacts, or termini, as the primary mechanism for aligning and connecting the optical fibers.

In many such aerospace applications, fiber optics are being employed as replacements or upgrades to existing copper conductor cable harnesses servicing existing black-box flight deck equipment, weapon systems, surveillance cameras, sensors, and so on. In all applications of this caliber, the new fiber optic system must adhere to the same rigorous qualification standards and performance requirements that applied to the legacy electrical systems.

For this reason, the design, configuration, and packaging of fiber optic interconnects has closely mirrored existing military standards, such as those covering interconnect mateability, accessory interface dimensions, and material finishes. The design of fiber optic termini, special purpose backshells, and other accessories is similarly controlled by existing packaging requirements and interconnect industry dimensional standards.

### High-Reliability Connectors

Ruggedized, high-reliability fiber optic connectors feature a bottoming surface design for reliable shell-to-shell bottoming. This ensures the linear dimensional relationship of the contact termini are the same after each connector mating because the connector effectively seats at a predetermined location each and every time. This location, or datum surface, provides a reference location back to the terminus retention clip. The pin and socket location is dimensioned from this stable bottom to achieve a repeatable and reliable connection. Conductive surface plating ensures EMI/RFI penetration into the electronics equipment area is effectively cut off. Precision molded shells and insulators provide closely controlled dimensions with little variability from one part to the next.

### Fiber Optic Interconnect Termini

Military-grade fiber optic connectors are designed to be connected and disconnected many times without affecting the optical performance of the fiber circuit. Connectors can be thought of as transition devices which make it possible to divide fiber optic networks into interconnect-ed subsystems and to facilitate the attachment of individual branches of the system to a transmitter, receiver, or another fiber. The MIL-DTL-38999 connector (Glenair SuperNine) is currently the most



Glenair's high-reliability fiber optic connectors, such as our SuperNine series of D38999 style products, are built to ensure precise optical alignment of optical fibers. Connector polarization keys, keyways and optical cavities are manufactured to tighter tolerances than required by general commercial specifications to reduce radial misalignment and insertion loss. Connector inserts may incorporate conventional physical contact termini, expanded beam termini, or ultra high-density MT assemblies.

commonly specified multi-pin cylindrical interconnect in both fiber and copper conductor aerospace applications. When used to connect multiple strands of fiber simultaneously, the D38999 connector functions as a container or shell for the precision termini that perform the actual marriage of the fiber strands.

Over the past two decades there have been dramatic tolerance improvements in terminus design to ensure precise, repeatable, axial and angular alignment between pin and socket termini within the connector shell. Ferrule design, critical to the performance of the termini, has traditionally relied on a machined stainless steel ferrule incorporating a precision micro-drilled hole. Glenair's unique precision ceramic ferrules are approximately 10 times more accurate than alternative designs and have reduced insertion loss values from 1.5dB to less than .5dB. These ceramic ferrules, with concentricity and diametral tolerances controlled within a micron (.00004 of an inch), meet the needs of high bandwidth and low insertion loss applications. Glenair's D38999 termini are qualified to MIL-PRF-29504.

In addition to SuperNine, a wide range of other signature single and multichannel fiber optic connectors—each optimized for different military branches and packaging requirements—are supplied by Glenair (see the Product Selection Guide presented later in this Buyer's Guide). In fact, Glenair offers the largest and most diverse selection of military-grade fiber optic interconnects in the world, including ultra high-density MT solutions with both conventional MTX ferrules, as well as next-generation PRIZM® MT expanded beam ferrules. All our signature interconnect series are supplied with a "no gaps" family of tools and specialized fiber optic backshells.

## Fiber Optic Backshells

Fiber optic strands are robust and reliable. But they may not be manhandled (clamped, bent, or crushed) with the same vigor one might employ when working with a crush-resistant copper conductor. For this reason, F/O connector and cable accessories are designed to reduce bending and to eliminate compression forces. Conventional connector backshells such as cable clamps and strain reliefs that apply compression forces directly to the cable, are not appropriate for use in



Glenair fiber optic backshells are designed to meet the specific requirements of rugged, military-grade fiber optic interconnect systems. The unique devices incorporate self-locking couplers, banding platforms for hybrid electrical/optical applications, full-radius 90° bends, adapters for PEEK conduit, purple color-coding for fiber optic links, and cable strain relief.

### Termini Retraction and Its Effect On Micro-Bending

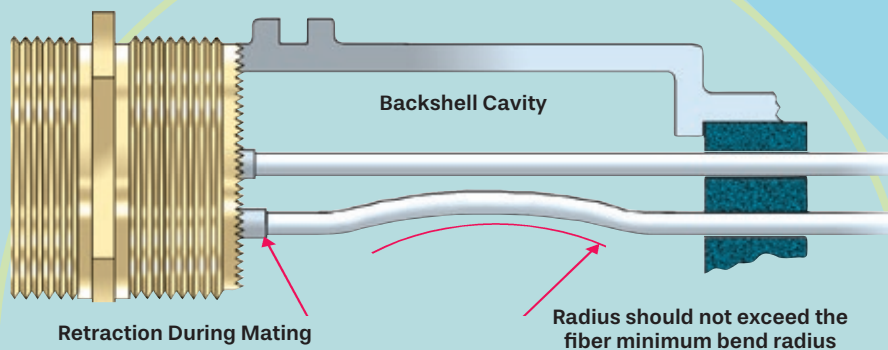

Fiber optic media may be damaged due to localized micro-bending of the material inside the backshell enclosure and so require the special protection provided by purpose-designed fiber optic backshells.

# BUYERS GUIDE INTRODUCTION: FIBER OPTIC INTERCONNECT TECHNOLOGY AND PACKAGING



FiberCon backshells utilize a unique rubber grommet which provides axial alignment, strain relief, and "float" for individual fibers.

fiber optic assemblies. Likewise, accessory elbows, conduit transitions, and other fittings which subject fiber optic cables to abrupt changes in direction beyond the acceptable bend radius of the fiber are equally risky. In both cases, the dangers are either outright breakage of the fiber optic core or attenuation of the optical signal.

Glenair's composite thermoplastic fiber optic accessories—including

elbows, transitions, and endbells—are designed with smooth 45° or 90° bends to ensure the non-abrupt routing of the cable. Composite Qwik-Clamps and heat shrinkable boots provide strain relief without applying severe compression to the cable. Glenair's cable overmolding capability enables the integration of unique straight or angular shapes directly into the cable to ensure the best possible fiber position and alignment.

Glenair FiberCon Backshells are specifically designed to meet the unique requirements of the media. For both single fiber leads as well as multi-channel applications, FiberCon backshells provide full support and vibration dampening while allowing the fiber to "float" as required to eliminate micro-bending. Fiber optic terminations differ from electrical in one critical way: during connector mating, the fiber optic spring-loaded socket or pin retracts from .040 to .080 inches. It is critical that the backshell design accommodates this movement within the shell cavity to prevent data loss due to micro bending, potentially leads to localized light refraction. The unique rubber support grommet utilized in the Glenair design employs the same layout pattern as the connector insert—providing necessary axial alignment as well as strain relief and float.

*When evaluating the costs and benefits of moving to fiber, it is important to adopt both a short and long term view.*

## Fiber Optic Costs and Benefits

In the short term, it is arguably less expensive to simply continue using copper cabling to meet an incremental expansion of data communication requirements. This avoids the expense of adding the transmitters, converters, repeaters, connectors, terminations, receivers and so on needed for integrating optical fiber into an existing electronic system.

Taking the long view, investing in the conversion to fiber optics often makes good sense, especially given the performance benefits—EMI immunity, security, weight reduction, bandwidth, etc.—as well as cost-of-ownership factors such as reduced cable maintenance costs and ease of installation. The ability to more easily accommodate future bandwidth requirements as well as the ability to incorporate redundant fibers for improved safety and reliability further reduces the long-term cost-of-ownership. Glenair has worked closely with engineers on a broad range of programs—from the F-22 to the Joint Strike Fighter—to analyze system requirements and to design high-reliability fiber optic solutions that meet both short- and long-term cost requirements, and the life-cycle projections for the application.

## Fiber Optic Connector and Cable Design

The design and layout of a fiber optic interconnect assembly can vary widely depending on the application environment. Fiber optics deployed in military avionics, for example, may take the form of a simplex pigtail connector assembly when fiber is used to interconnect the optical transmitter/receiver inside an equipment enclosure to the outside world via a panel mounted receptacle connector or feed-thru adapter. Rugged, environmental applications, such as a weapon interconnect cable intersecting a fuel tank, may require more ruggedized cable design and construction. Long-run, point-to-point fiber optic cabling in battlefield or secure bunker applications are typically cabled in spools with hermaphroditic connectors.

Specialized interconnect technologies, including unique backshells, conduit transitions, and fiber alignment grommets are regularly employed by Glenair to ensure the fiber optic media is protected from environmental and physical damage while meeting the installation and repairability requirements of the application. The following guide to fiber optic interconnect cable design provides an overview of the most common layouts used in high-reliability applications:

### Design Solutions for Inside the Box

When fiber leads are used within equipment enclosures or other protected environments, the interconnect assembly generally looks something like the figure to the right: a panel mount or jam nut mount receptacle connector ("A") with simplex fiber leads. This receptacle connector is used to penetrate the enclosure and mate to the external environmental plug connector.

The simplex leads within the protected enclosure commonly route to the transceiver optical device and are terminated to common commercial connectors such as ST, FC, SC, LC, MT (or other) connectors at the "B" end.

Glenair can also build pigtail assemblies of this type with a FiberCon backshell and/or a protective length of conduit. This design approach ensures strict alignment of the fiber strands to the connector, optimum strain relief to the individual fibers as well as crush protection.

The use of a short length of conduit and a small endbell fitting is recommended in applications where a heat or abrasion source within the box may damage the fiber media. In most cases, analysis of the available space is critical to ensure such interconnect hardware does not interfere with the electronics package inside the box. This basic design is appropriate for any equipment—such as a radar, camera, shipboard console, antenna and so on—with an internal fiber wire servicing an optical transmitter/receiver.

Glenair can supply the complete interconnect assembly with off-the-shelf (COTS) components including connector, termini, fiber, backshell, and conduit. Glenair ASAP F/O Cable Sets are specifically designed for applications of this type when a customized solution is not required.

A typical "inside-the-box" fiber optic cable assembly. Cables of this type are now available as a standard short-lead catalog product from Glenair.

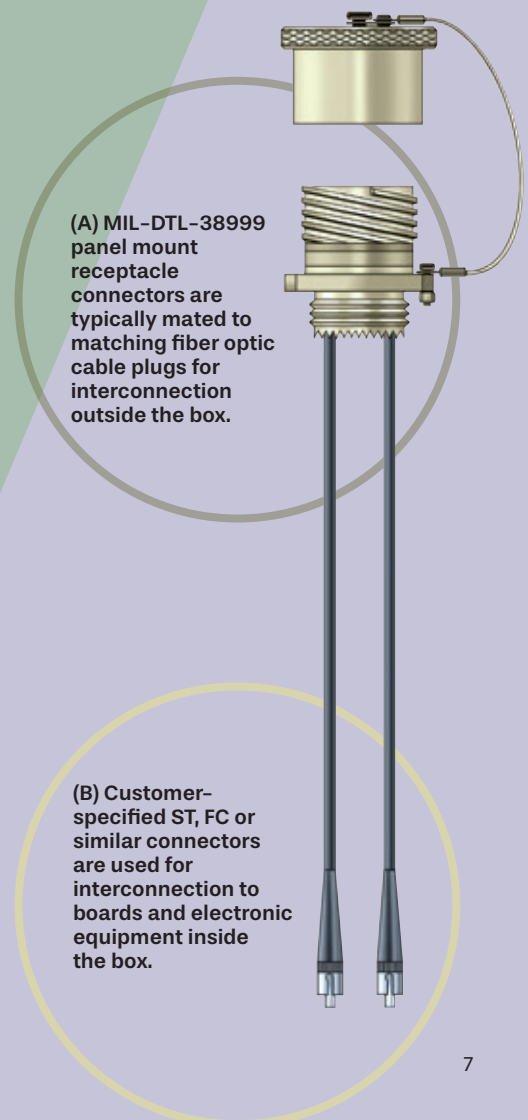

(A) MIL-DTL-38999 panel mount receptacle connectors are typically mated to matching fiber optic cable plugs for interconnection outside the box.

(B) Customer-specified ST, FC or similar connectors are used for interconnection to boards and electronic equipment inside the box.

# BUYERS GUIDE INTRODUCTION: FIBER OPTIC INTERCONNECT TECHNOLOGY AND PACKAGING



Glenair fiber optic connectors, termini, and cables are on-board the F-35 Joint Strike Fighter.

## Cable Design Solutions for External Point-to-Point Applications

While inside-the-box applications may be conveniently terminated in the field during the installation of the electronic equipment, other fiber optic interconnect cables lend themselves to factory termination and assembly. This is due to the rugged nature of the environments in which they are used. When fiber optic cables need to withstand rough handling, caustic and corrosive fluids, or other sources of physical or environmental stress, the interconnect package design needs to be extremely tough, with factory-terminated cables outfitted with the appropriate protective materials. Factory assembly is also called for when there are no restrictions or impediments to providing a pre-built harness or assembly, such as unpredictable distances between bulkheads or other site-specific routing problems. Factory-terminated fiber optic cables are typically multichannel, with as many as 70 fiber optic channels or more. Examples include ship-to-shore phone/data cables, fuel cell cable harnesses, intra-car railway cables, and other harsh environmental applications.

The range of performance requirements for rugged, external cables includes strain-relief, environmental sealing, high tensile pull, crush resistance, and chemical resistance. Electromagnetic shielding can also be a requirement in hybrid copper/fiber cables. Packaging generally takes three forms: **1) Overmolded cable harnesses**, **2) Metal-core or polymer-core conduit assemblies**, and **3) Armored cable equipped with environmental and/or shield terminating backshells**.

## Overmolded Harnesses



Glenair high-temperature overmolded cable assemblies are ideally suited for fiber optic and hybrid fiber/copper applications in harsh environments. Overmolding of fiber is a unique Glenair strength and has been utilized as a packaging solution in such diverse applications as fighter jet fuel-cell cables and rooftop telecommunication cabling.

Overmolded designs are specified when field reparability is not an anticipated requirement and harsh environmental and mechanical stress conditions warrant extra protection of the fiber media and terminations. Overmolding technology employs specialized tooling to construct ruggedized, sealed transitions between the cable and the connector and any transition hardware. Overmolding is ideally suited for complex multi-leg harnesses because the many transitions are otherwise difficult to seal with conventional shrink-boots. Overmolding typically uses environmentally resistant jacketing such as Polyurethane. Overmolded cables are extremely rugged and can protect the factory terminations from a broad range of environmental and



mechanical stress generation mechanisms. Glenair can integrate its own fiber optic connectors, backshell accessories, termini and cable into such cables—providing a complete, turnkey system. Glenair also offers ASAP point-to-point overmolded cable sets with plug-to-plug, plug-to-receptacle, and receptacle-to-receptacle connectors as a standard catalog offering. And because termini retraction is a critical requirement of MIL-DTL-38999 type connectors, Glenair's unique FiberCon backshells—that facilitate termini retraction and eliminate micro-bending—are a critical component in every overmolded cable.



**Conduit provides an ideal packaging media for fiber optic cables. The material is highly flexible and can be terminated at the factory with a wide range of shielding, jacketing, and other specialized materials. Conduit may be opened for maintenance and repair or to expand the number of lines.**

## Conduit Assemblies

Conduit is a perfect material for the protection of fiber optic media and for the construction of factory-terminated assemblies. As a wire protection material, conduit has a number of unique advantages over other packaging, such as armored cable and even overmolding. First and foremost, conduit systems offer greater flexibility than other ruggedized designs. This is critical in applications such as intra-car railway data transmission lines where the ability of the harness to flex and bend with the repetitive motion of the rail car is a critical requirement. Conduit is also known for its excellent pull strength, high crush resistance, and relative light weight. Perhaps most important, conduit fittings and transitions can more easily be opened for repair or to expand the number of fiber lines. Additionally, conduit assemblies make use of a wide range of existing fittings and transitions, including lightweight composite versions, to meet virtually any configuration and lay-up requirement.

Glenair offers complete in-house capabilities for the construction of fiber optic conduit assemblies. In addition to helically molded polymer materials, we also offer a metal-core conduit product which provides unmatched crush-resistance and EMI protection (for hybrid copper/fiber applications). Both styles of tubing may be outfitted at the factory with braided shielding and external jacketing, or supplied as discrete components for customer assembly. Glenair manufactures all the necessary branched transitions and fittings for every connector and/or feed through configuration.



**Glenair offers a complete wire-routing solution with conduit adapters and multi-branch transitions including Y, T, Double Y, and Double T transitions.**

# BUYERS GUIDE INTRODUCTION: FIBER OPTIC INTERCONNECT TECHNOLOGY AND PACKAGING

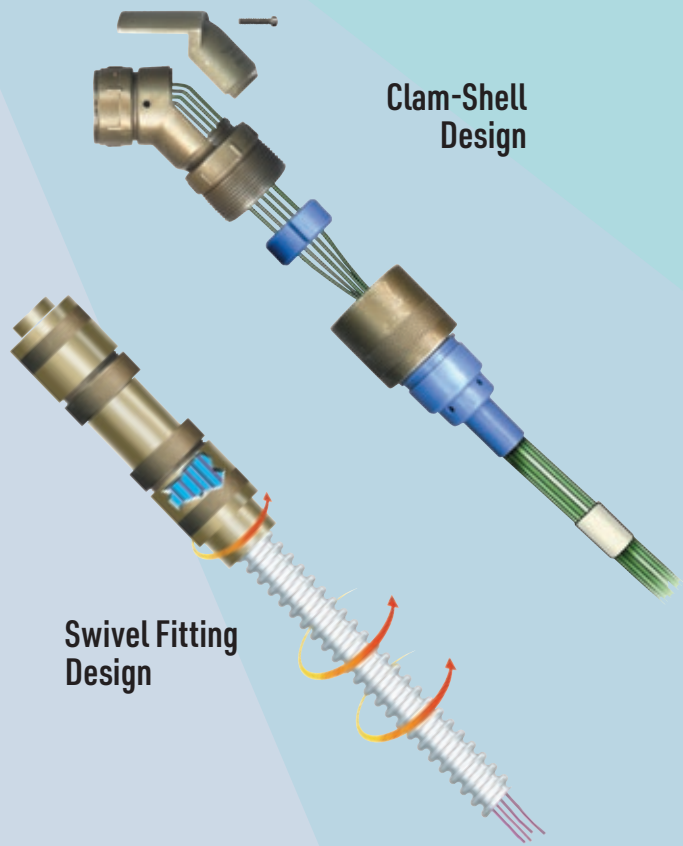

## Reinforced Cable/ Backshell Assemblies

Reinforced extruded cable provides a third packaging option for rugged application environments. Multichannel fiber optic cable is available in a broad range of designs. Depending on customer requirements for fiber type, strength members, jacketing material, and other component-level options.

Glenair can extrude short-run fiber optic cable for most high-performance applications. The cable becomes the backbone of this packaging solution. A ruggedized, environmental backshell is an equally key component in the armored cable assembly. Such backshells allow for the termination of overall shielding, the provision of additional strain-relief, and/or environmental protection of the cable to connector transition.

But the most important design consideration behind the use of such specialized backshells is the ability to provide some level of repairability to the assembly. Unlike overmolded solutions, the reinforced extruded cable/backshell package allows maintenance technicians to open the cable for field service. Backshells are selected for functionality (strain-relief, shield termination, and so on) and for compatibility with the chosen connector. Glenair is able to provide turnkey assemblies of this type as well as all the discrete components—from the extruded cable to the backshells, connectors, termini, dust-caps, and other fiber optic interconnect accessories.

The fiber optic backshell pictured above (top) features a "Clam-Shell" opening, as well as a tensioning device to prevent overtightening of the backshell clamp. The Swivel Fitting assembly pictured (bottom) is designed to prevent cable torque from affecting fiber alignment. Both are suited for use with standard extruded cable or conduit.

*Junction Boxes may be used to resolve difficult routing and stowage issues in unpredictable fiber optic cable runs.*

## Retractable Backshell and Box Solutions for Field Termination

A final packaging category for fiber optic interconnect applications covers those situations in which a pre-assembled cable or harness cannot be used due to the difficulty of cable installation and routing. A classic example is found in shipboard installation, where the fiber optic cable often has to travel a great distance between the various equipment components in the system. A below-deck control room, for example, may rely on sensors or communications equipment located on the mast of the ship. Between these two elements lies a complicated maze of deck-plating, penetrable bulkheads, and kick-pipes.

Obviously, it would be impossible to install a factory-terminated assembly into this maze of holes and walls. So, long (trunk) cable runs are designed from point "A" to point "B," and the termination of the fiber optic datalink is completed on site at each end of the cable. The challenge is to provide technicians with the ability to strip back an adequate length

of the cable to complete the individual fiber line terminations as well as some subsequent way to protect the stripped-back cable from environmental damage.

One solution to the problem is to mount a junction box at each end of the system and bring the trunk cable into the box for subsequent termination of the contacts and protection of the media. Such junction boxes also aid in the routing and storage of the fiber leads. The boxes may be positioned in a centralized location to provide service to multiple pieces of electronic equipment. Additionally, long lengths of stripped cable can be sealed away in the box for subsequent repair and maintenance. Typical box configurations feature either convoluted tubing and environmental feed-through fittings, or in-line and box-mounted fiber optic connectors. Glenair is uniquely positioned to provide integrated fiber optic cable junction boxes of this type. Our line of CostSaver Composite Junction Boxes are specifically designed for use in harsh EMI and environmental applications where field termination of fiber media is a difficult and cumbersome operation.

Glenair's background in providing fiber optic interconnect solutions for the Navy has led to the development of unique solutions for field termination of fiber. Glenair offers numerous backshell and conduit assemblies that perfectly suit this requirement. As the illustration below depicts, this Glenair retractable backshell and conduit assembly provides all the working room necessary for easy field termination of the fiber.

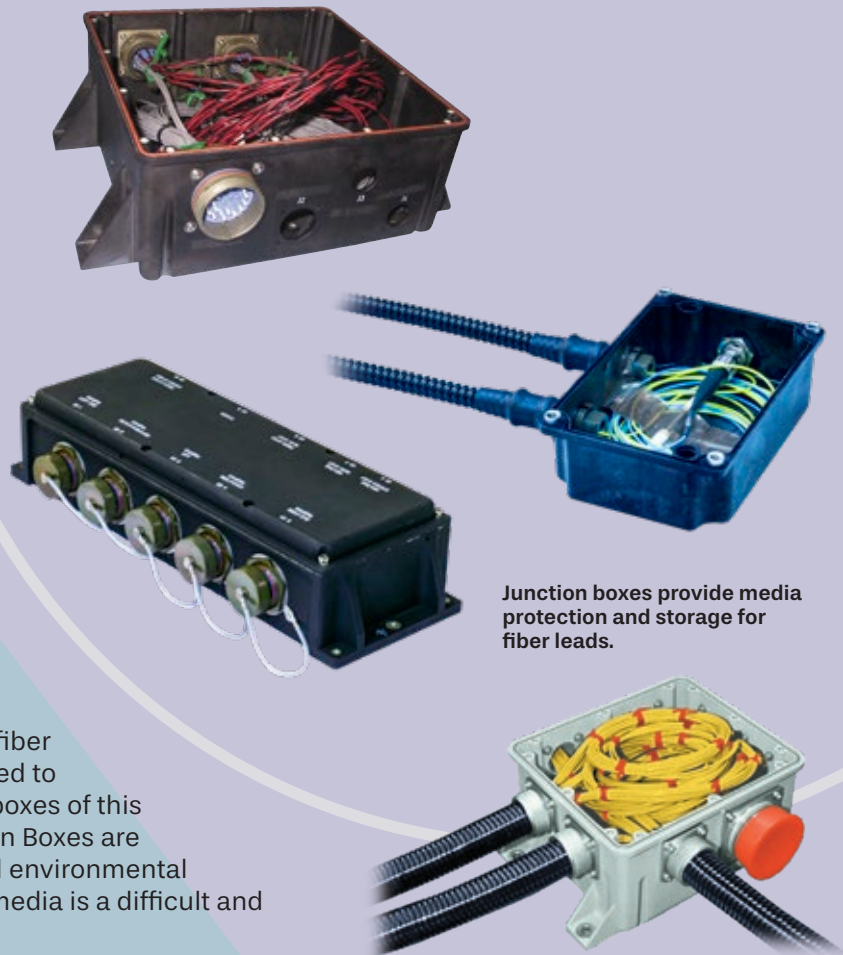

Junction boxes provide media protection and storage for fiber leads.

Retractable backshell and conduit assemblies provide working room necessary for field termination of fiber.

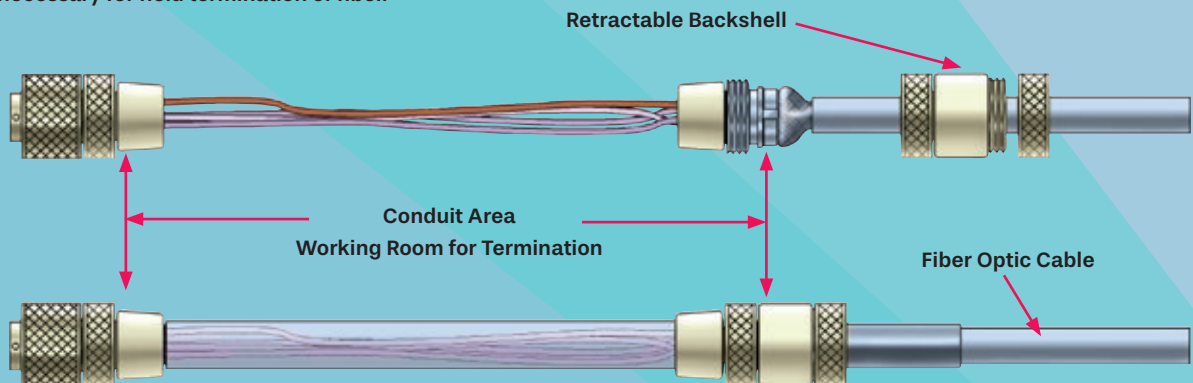

# FIBER OPTIC

*Five key benefits of fiber optic datalinks in mission-critical land, sea, air, and space applications*

Fiber optic datalinks can transmit the equivalent of 24,000 telephone calls simultaneously through media thinner than a human hair—and do so over longer distances than would ever be possible with even the most high-speed copper media and datalink protocol. But the advantages of fiber optics extend far beyond this mind-boggling data transmission rate to include:



## 1 Reduced Size and Weight



Compared to copper, optical fiber is relatively small in size and light in weight—a major advantage in interconnect systems servicing airborne avionics, sensors, radar, fly-by-light flight controls, and other applications. Optical fiber is easier to install—especially in retrofit programs—since smaller cable diameters fit comfortably within the footprint or layout of existing electrical conduits and harnesses.

This reduction in media size makes it possible to run multiple backup cables for critical electronic systems or devices. The ability to provide complete redundancy for all critical cabling is a major factor driving the use of fiber optics in mission-critical applications.

## 2 EMI Immunity

Optical fiber is frequently applied in mission-critical interconnect applications due to its electromagnetic immunity. Since fiber optic media uses light to transmit signals, it is not subject to electromagnetic interference, radio frequency interference, ESD, or voltage surges, and so provides greater transmission reliability—particularly in military / aerospace applications that absolutely depend on error-free data transmission.



### 3 Unsurpassed Bandwidth Over Long Distances

Fiber can transmit a mind-boggling quantity of data with extremely good transmission quality over long distances: Up to 150 times the data carrying capacity of bulkier copper cable. And since most high-speed data protocols transmit digitally, optical media reduces translation errors and bottlenecks—particularly over longer cable-run distances such as those found in Navy ships and ground-based shelter and vehicle applications.



### 4 Spark/Arc Immunity

The total electrical isolation of fiber also makes it a safer, spark-free media for use in hazardous environments, such as aircraft fuel cells or other applications where volatile gasses might be present. As only light, not electricity, is being transmitted, there is no risk of a spark or short-circuit from a damaged cable. For this same reason there is no shock hazard or risk to users performing routine maintenance to interconnect cabling. As a result, fiber optic media is routinely specified for use in Class I, Division I (Ex) environments such as are found on Navy ships, commercial tankers and other enclosed environments where the risk of a spark/arc event is considered a severe safety hazard.



### 5 Enhanced Security

Light pulses, unlike electrical signals, are almost impossible to intercept or monitor. Fiber optic media therefore enjoys total immunity from wiretapping. This characteristic is particularly valuable to military services, banks, and operators of secure networks. In addition to enhanced transmission security, photonic fiber media itself is invisible to metal or electromagnetic flux detection equipment.



# FIBER OPTIC

Five key reasons  
OEMs choose Glenair  
fiber optics

## 1 Massive US and UK factory capacity and capability

Glenair's Southern California and UK facilities house the largest and most professionally staffed mission-critical fiber optic interconnect manufacturing and assembly operations in the world. Both facilities are fully redundant for ultimate customer peace of mind.



Glenair qualified MIL-PRF-28876 fiber optic interconnect system



## MASSIVE CNC MACHINING CAPACITY

The high-reliability interconnect industry's largest precision metal turning operation—US and UK.

## PRECISION POLISHING, TERMINATION, AND ASSEMBLY

Glenair harsh-environment fiber optic connectors, cables, and termini are precision-polished and terminated by trained and certified professionals. Fiber optic operations in the US and UK both offer turnkey military/aerospace-grade fiber optic harnesses and multibranch interconnect assemblies.



*Glenair delivers the fastest, highest-quality turnaround on production orders in the high-rel interconnect industry*

GLENAIR  
**QwikConnect**



### **INSPECTION AND TEST**

Each and every fiber optic circuit is 100% tested and inspected prior to shipment.

### **SMALL-VOLUME, HIGH-TOUCH**

Glenair's fiber optic teams can accommodate both large-volume orders as well as the many small-volume requirements common in mil-aero and harsh-industrial markets.



### **MASSIVE INVENTORY**

Glenair's ability to respond quickly to customer requirements is uniquely met by our massive inventory of both component stock as well as ready-to-ship fiber optic interconnects, termini, and cables. Both our US and UK factories are fully able to support the Glenair commitment to high availability and fast turnaround on catalog and bespoke orders.

# BUYERS GUIDE INTRODUCTION: FIVE KEY REASONS OEMs CHOOSE GLENAIR FIBER OPTICS

## 2 F/O systems optimized for harsh environments

Glenair fiber optic interconnects carrying digitized video, voice, and data are broadly deployed in harsh application environments including aircraft avionics, military ground systems, shipboard weapon platforms, sub-sea sensors, satellite communications, and other mission-critical platforms. Highly engineered fiber optic termini, tight-tolerance connectors, and turnkey cable assemblies are optimized by Glenair to meet each environment's unique requirements and deliver reliable, repeatable, low-data loss performance.



Glenair High Density (GHD) fiber optic connection system

## Military AEROSPACE

- SuperNine MIL-DTL-38999 type with M29504 termini
- Glenair High Density (GHD) with keyed genderless termini



- Low mass
- Dynamic vibration and shock resistance
- Extreme temperature resistance
- Environmentally sealed
- Corrosion resistance
- Flammability, toxicity, low-smoke
- Indirect lightning strike
- Ease-of-maintenance
- Uncompromised reliability

## Commercial AEROSPACE

- Series 806 Mil-Aero micro miniature with size #20HD termini
- ARINC 801 series genderless termini for D38999 type and other commercial aerospace grade connectors



- Dynamic vibration and shock resistance
- Extreme temperature resistance
- Environmentally sealed
- Pressurized and non-pressurized zones
- Corrosion-resistance
- Flammability, toxicity, low-smoke
- Indirect lightning strike
- Ease-of-maintenance
- Uncompromised reliability



High-performance, low-dB loss  
F/O interconnects optimized  
for rugged environmental  
applications—military and  
commercial

GLENAIR  
**QwikConnect**

## SPACE and Satellites

- Glenair signature ruggedized MT ferrule-equipped connectors
- Eye-Beam POWER expanded-beam for Free Space Optical applications

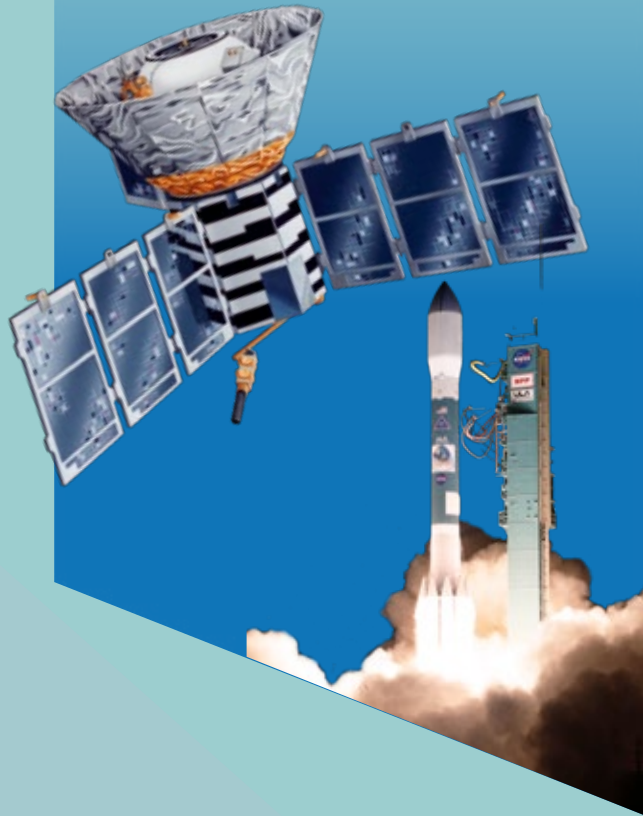

- Low mass
- High channel density
- Dynamic vibration and shock resistance
- Temperature Extremes
- Outgassing certifications
- Radiation hardened / tested
- Non-magnetic
- Flight heritage
- Uncompromised reliability

## NAVAL Subsea Marine/

- MIL-PRF-28876 QPL shipboard fiber optic connectors
- SeaKing 700 Fiber high-pressure 10K PSI open-face rated subsea



- High channel density
- Dynamic vibration and shock resistance
- Environmentally sealed
- Pressure resistance
- Corrosion resistance
- Flammability, toxicity, low-smoke
- Ease-of-maintenance
- Uncompromised reliability

# BUYERS GUIDE INTRODUCTION: FIVE KEY REASONS OEMs CHOOSE GLENAIR FIBER OPTICS

## 3 Low-loss and low maintenance termini

Butt-joint fiber optic termini and connector designs can be broken into two major categories. Rear-release termini are typically designed for use with connector housings that were originally conceived as electrical connectors — such as the MIL-DTL-38999 Series III — with contact retention and environmental sealing integral to the connector insert design. Front-release termini, on the other hand, integrate environmental O-ring sealing features and termini retention clips directly into the terminus body itself, allowing for higher density (more termini per connector). Certain Glenair front-release fiber optic connectors (Glenair High Density, GHD) also offer easier keying for APC polish applications in a front-release design.



### ANATOMY OF REAR-RELEASE OPTICAL TERMINI

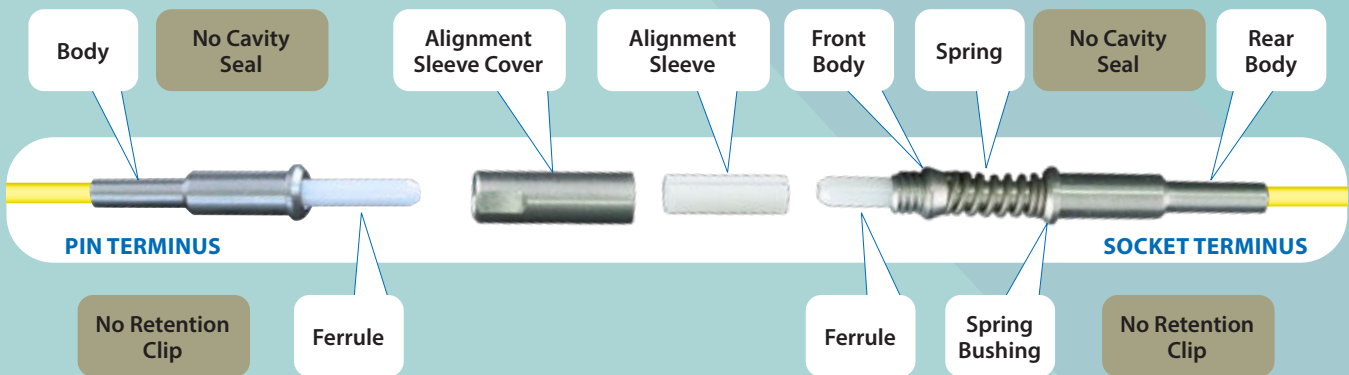

M29504/04 Pin and M29504/05 Socket Termini for US Navy Avionics Applications

### ANATOMY OF REAR-RELEASE CAVITIES

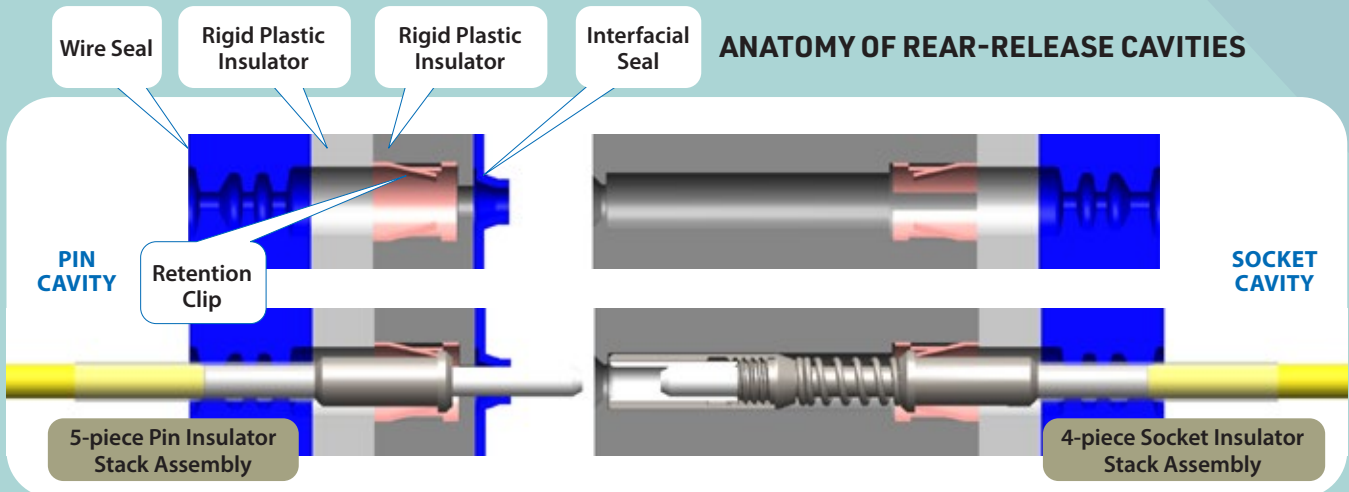

D38999 Series III Size 16 Pin and Socket Cavities for US Navy Avionics Applications

Low-dB loss front-release, rear-release, and expanded-beam termini deliver reliable, low-maintenance performance

**ANATOMY OF FRONT-RELEASE OPTICAL TERMINI**

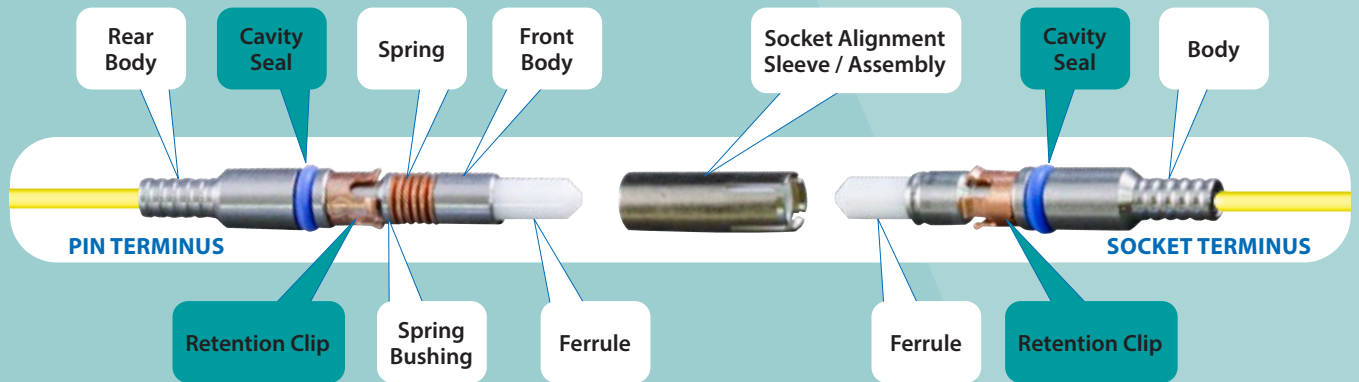

M29504/14 Pin and M29504/15 Socket Termini for US Navy Shipboard Applications

One-Piece Pin and Socket Inserts

**ANATOMY OF FRONT-RELEASE CAVITIES**

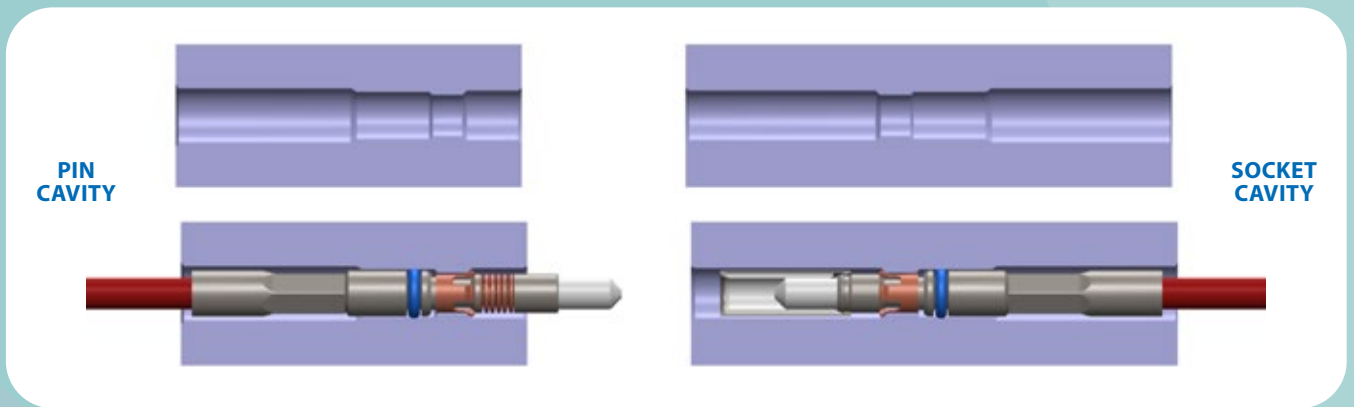

M28876 Pin and Socket Cavities for US Navy Shipboard Applications

**OTHER GLENAIR SIGNATURE LOW dB LOSS TERMINI DESIGNS AND APPLICATIONS**



Glenair signature ruggedized packaging for MT ferrules

Innovative GRIN-lens expanded beam termini

Eye-Beam POWER drop-in size #8 termini for FSO applications

Sr. 806 micro form-factor (size #20HD) optical termini

# BUYERS GUIDE INTRODUCTION: FIVE KEY REASONS OEMs CHOOSE GLENAIR FIBER OPTICS

## 4 Next-gen connector package designs

In addition to standard environmental stress factors (moisture and dust ingress), there are two mechanical stress factors that are particularly important to consider when designing butt-joint (physical contact) fiber optic connectors: vibration and shock resistance. This is because the weight of vibration and shock is felt exactly where "repeatable and reliable performance" is most readily compromised—at the fiber optic termini mating interface. The effects of vibration in a cable can best be visualized as a wave on a rope, with the highest concentration of stress occurring at the end point or termination. Glenair has mastered the art of building both circular and rectangular fiber optic connectors and insert assemblies housing butt-joint termini that are capable of resisting the highest levels of military and aerospace application vibration and shock.



### SPOTLIGHT ON GLENAIR GHD HIGH VIBRATION AND SHOCK CONNECTOR AND INSERT PACKAGING OPTIMIZED FOR RELIABLE AND REPEATABLE LOW dB LOSS PERFORMANCE

GHD's shell-to-shell bottoming enables mating insert cavities to "square up" to each other in a repeatable manner, ensures consistent spring force at working height, and prevents movement between mating connectors during harsh shock and vibration exposure. The connector interface is sealed with a piston-style O-ring seal for robust environmental protection.



Guide Pins

Removable Alignment Sleeve Retainer with Guide Pins

Guide pins facilitate repeatable optical performance by ensuring alignment between mating cavities. Threaded-coupling connectors without guide pins can "sweep" relative to each other when torqued. Misaligned cavities will force the split ceramic alignment sleeve to work harder to bring mating termini into alignment. Stressed alignment sleeves can expand (and possibly break), resulting in high optical loss.

### SUMMARY OF GHD SERIES CONNECTOR PACKAGE DESIGN ELEMENTS

- Low mass
- Dynamic vibration and shock resistance
- Extreme temperature resistance
- Environmental sealing
- Corrosion resistance
- Flammability, toxicity, low-smoke rated
- Removable alignment sleeve for ease-of-maintenance
- Uncompromised reliability

# Connector shells and coupling mechanisms optimized for resistance to vibration, shock, and environmental stress factors

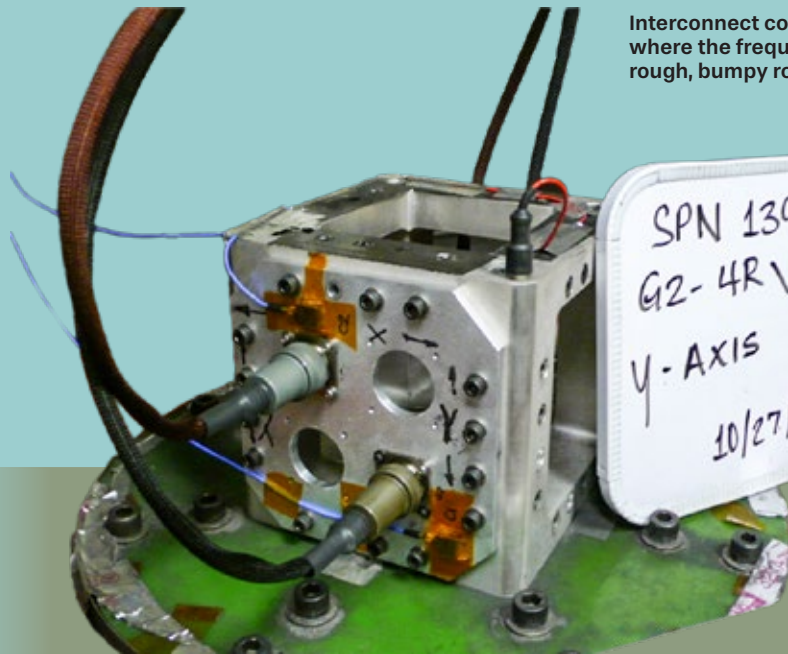

Interconnect components are aggressively tested for random vibration, where the frequency and magnitude vary with time—like a car riding on a rough, bumpy road.

Figure 11: Random Vibration (Series I, III and IV)

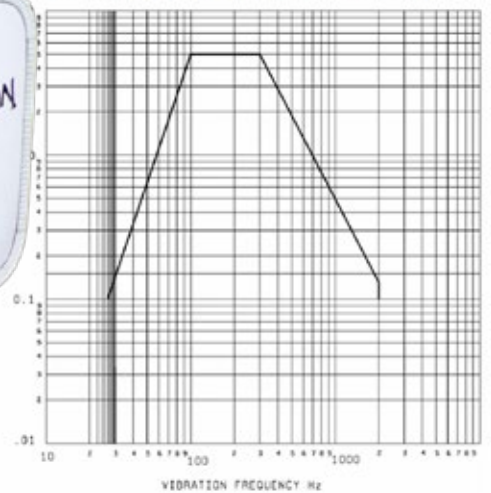

## SPOTLIGHT ON GLENAIR PACKAGING OF BOTH PRIZM® MT AND MT ELITE® FERRULES IN RUGGEDIZED MILITARY-GRADE CIRCULAR, RECTANGULAR, AND BACKPLANE CONNECTORS

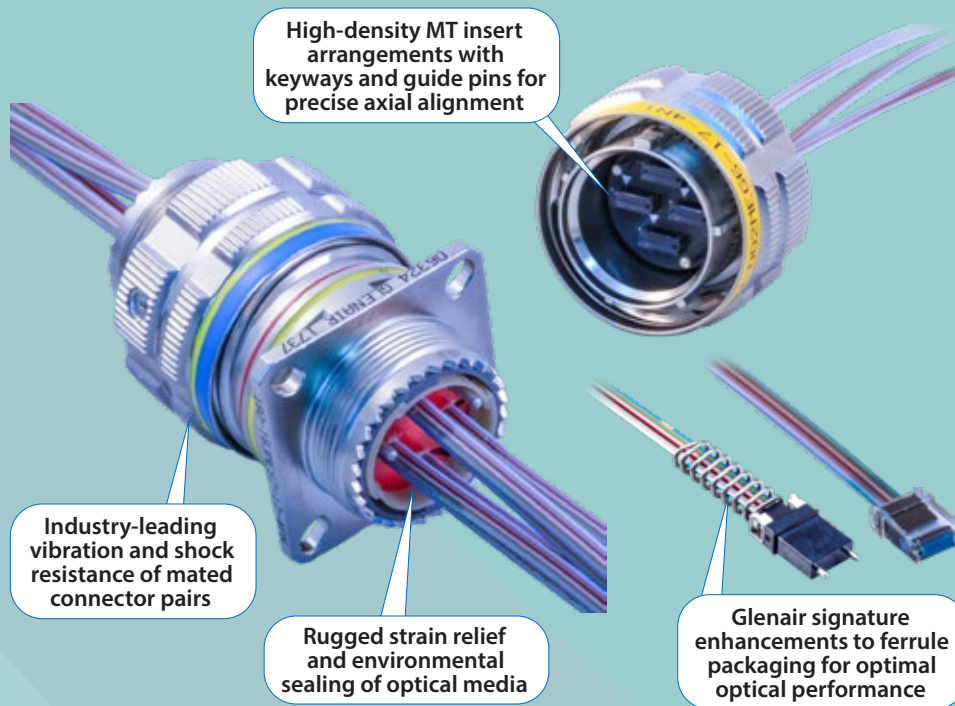

- Easy-to-use, harsh environment, super high-density PRIZM® MT expanded-beam fiber optic assemblies in Glenair ruggedized I/O and backplane connector packaging
- Glenair is qualified by US Conec to terminate 1 and 2 row PRIZM® MT ferrules for ribbon and round cable fiber
- Reliable, repeatable optical performance
- PRIZM® MT ferrule is tolerant to contamination
- Outstanding sealing against debris contamination

# BUYERS GUIDE INTRODUCTION: FIVE KEY REASONS OEMs CHOOSE GLENAIR FIBER OPTICS

## 5 Turnkey / ruggedized F/O cables and harnesses

Glenair manufactures every popular mission-critical fiber optic interconnect system including MIL-DTL-38999 type, MIL-PRF-28876, and ARINC 801. Our fiber optic cable assembly team can integrate these ruggedized, military-grade fiber optic technologies into turnkey cable and harness assemblies—terminated, tested, and ready for immediate use. Examples shown here range from inside-the-box pigtail assemblies to harsh environmental aerospace cables, junction boxes, and hybrid optical / electrical solutions.



Hybrid environmental overmolded fiber optic / electrical cable assembly, MIL-DTL-38999 type with 29504/4 and /5 QPL termini



Hybrid optical / electrical assembly for weight reduction in a high-speed datalink application



Harsh environment overmolded MIL-DTL-38999 Series III type composite



High-density Next-Generation (NGCON) fiber optic harness assembly



High-density SuperNine MT fiber optic breakout assembly



Cable reels and field-deployment technologies for both Glenair GFOCA and Eye-Beam® GMA fiber optic systems



GFOCA I/O-to-board assembly with overbraiding for mechanical protection

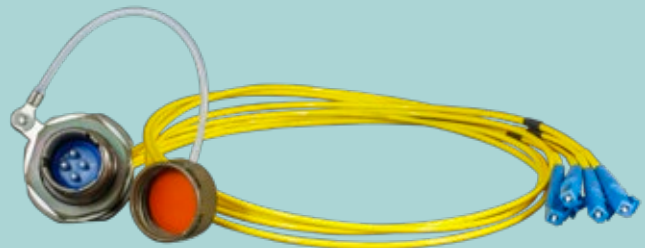

Inside-the-box MIL-DTL-38999 type I/O connector to board cable harness

*Glenair factory-terminated cable assemblies save time, money, and improve reliability of fiber optic interconnect systems*



Hybrid MIL-DTL-38999 Series III type fiber optic / electrical cable junction box



Harsh environment repairable MIL-DTL-38999 Series III type with FiberCon backshell to prevent fiber media damage



Field-deployable hermaphroditic GFOCA fiber optic cable assembly



Fiber optic multibranch assembly with flexible conduit wire protection and integrated cable storage bay



Point-to-point fiber optic cable with integrated strain relief



Turnkey Optical Flex circuit assembly with ruggedized MT Elite® and PRIZM® MT ferrule terminations

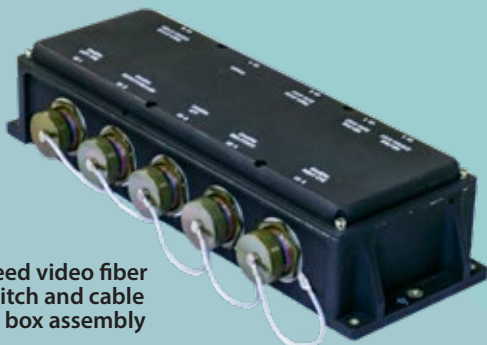

High-speed video fiber optic switch and cable junction box assembly

# BUYERS GUIDE INTRODUCTION: FIVE KEY REASONS OEMs CHOOSE GLENAIR FIBER OPTICS

## 5 Turnkey / ruggedized F/O cables and harnesses

The starting point for bespoke fiber optic cables and harnesses is the determination of the basic requirements of the cable. Together with drawings and basic dimensional details, this Application Checklist may be used to begin the custom cable assembly process at Glenair

### Application Specifications

#### Working Environment

- Shipboard
- Airframe
- Avionics
- Secure Communications
- Ground Support/Soldier System
- Armored Vehicle
- Rail/Mass Transit
- Space
- Missile Defense
- Telecommunications
- Industrial
- Downhole or Surface Use
- Other

#### Cable Installation

- Outdoor
- Indoor
- Internal-to-Equipment

#### Temperature Requirements

Operating: - °C=\_\_\_\_\_ +°C=\_\_\_\_\_

Storage: - °C=\_\_\_\_\_ +°C=\_\_\_\_\_

### Optical Fiber Requirements

#### Singlemode

Number of fibers \_\_\_\_\_

Fiber Size

- 9/125 μm
- Other

Test wavelength

- 1310 nm
- 1550 nm

Acceptable optical dB insertion loss

- Less than .5 dB
- Less than 1.0 dB

Acceptable optical return loss (backreflection)

- Not applicable
- \_\_\_\_\_ dB

#### Multimode

Number of fibers \_\_\_\_\_

Fiber Size

- 50/125 μm
- 62.5/125 μm
- 100/140 μm
- Other

Test wavelength

- 850 nm
- 1300 nm

Acceptable optical dB insertion loss

- Less than .5 dB
- Less than 1.0 dB

### Cable Harness Construction

#### Assembly Length Requirements

- Less than 10 Meters
- 10 to 150 Meters
- More than 150 Meters

#### Cable Type

- Buffered
- Simplex
- Distribution
- Breakout

#### Basic Harness/Assembly Description

- Open Wire Harness
- Repairable/Jacketed
- Overmolded (MIL-M-24041 Materials)
- Metal/Fabric Overbraided
- Conduit

#### Alternative Wire Protection Media

- High Flexibility Convuluted Tubing
- EMI/EMP Metal-Core Conduit
- Molded Shrink Boots
- Junction Boxes and Cable Bays



# Glenair factory-terminated cable assemblies save time, money, and improve reliability of fiber optic interconnect systems

## Strain relief

- Not Applicable
- Light Duty
- Medium Duty
- Heavy Duty

## Level of Environmental Protection

- Not Applicable
- Moisture Resistance
- Full Water Immersion
- Chemical/Caustic Fluid Resistance
- Extreme Corrosion Resistance
- Intense Atomic Radiation

## Special Considerations

- RoHS Compliant Materials
- Extreme Temperature Tolerance
- UL94-VO Flammability
- UV Resistance
- Radiation Resistance / Atomic Oxygen
- Field Repairability
- Crush/Abrasion Resistance
- Weight Reduction
- Size or Shape Restraints as Specified:

---

---

---

---

List jacket/sheath or other wire/fiber protection materials such as conduit, including material type and series:

---

---

---

---

## Fiber Optic Termination Assembly

### Connector

- Jam Nut or  Square Flange or  Plug
- Pin  Skt  Genderless  Contact Qty\_\_\_\_\_

MIL-DTL-38999 Series III Type \_\_\_\_\_

SuperNine® MT \_\_\_\_\_

Series 79® MT \_\_\_\_\_

ARINC 801 \_\_\_\_\_

Glenair High Density (GHD) \_\_\_\_\_

Series 806 Mil-Aero \_\_\_\_\_

Eye-Beam™ GMA \_\_\_\_\_

Eye-Beam™ GLT \_\_\_\_\_

Eye-Beam™ POWER \_\_\_\_\_

Glenair Front Release (GFR) \_\_\_\_\_

MIL-PRF-64266 (NGCON) Type \_\_\_\_\_

GFOCA \_\_\_\_\_

MIL-PRF-28876 \_\_\_\_\_

Termini Part No. \_\_\_\_\_

Dust Cover:  Yes  No

## Fiber Optic Breakout Assembly

### A Connector

- Jam Nut or  Square Flange or  Plug
- Pin  Skt  Genderless  Contact Qty\_\_\_\_\_

MIL-DTL-38999 Series III Type \_\_\_\_\_

SuperNine® MT \_\_\_\_\_

Series 79® MT \_\_\_\_\_

VITA 66 MT \_\_\_\_\_

ARINC 801 \_\_\_\_\_

Glenair High Density (GHD) \_\_\_\_\_

Series 806 Mil-Aero \_\_\_\_\_

Eye-Beam™ GMA \_\_\_\_\_

Eye-Beam™ GLT \_\_\_\_\_

Eye-Beam™ POWER \_\_\_\_\_

Glenair Front Release (GFR) \_\_\_\_\_

MIL-PRF-64266 (NGCON) Type \_\_\_\_\_

GFOCA \_\_\_\_\_

MIL-PRF-28876 \_\_\_\_\_

Termini Part No. \_\_\_\_\_

Dust Cover:  Yes  No

### B Connector

MT Elite® Connector \_\_\_\_\_

PRIZM® MT Connector \_\_\_\_\_

ST Connector \_\_\_\_\_

FC Connector \_\_\_\_\_

SC Connector \_\_\_\_\_

SMA Connector \_\_\_\_\_

LC Connector \_\_\_\_\_

Other \_\_\_\_\_

# Got a light?

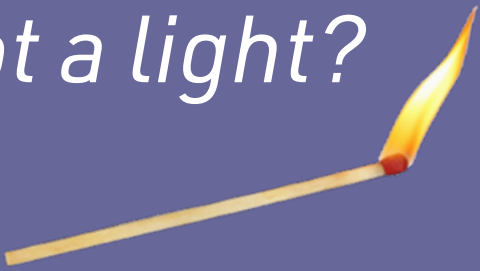

Change three matchsticks into six without breaking any of them

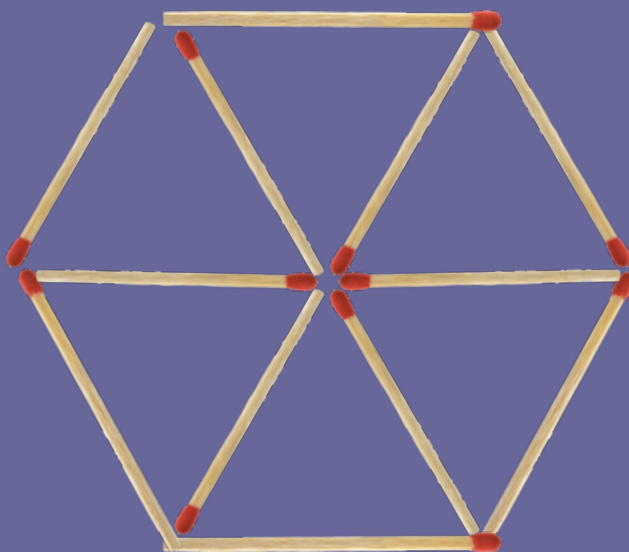

Move four matchsticks to make three equilateral triangles

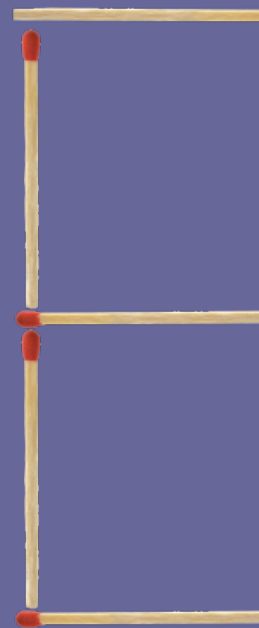

Move three

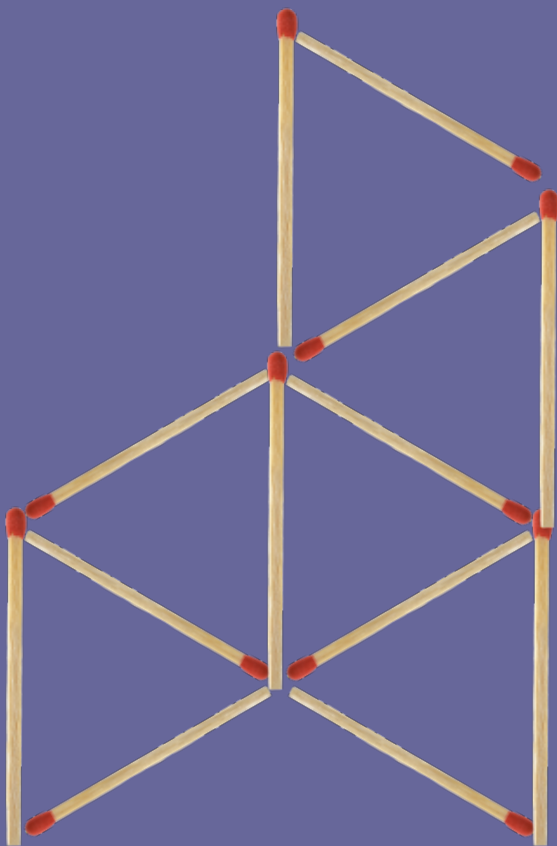

Remove four matchsticks to leave just three triangles

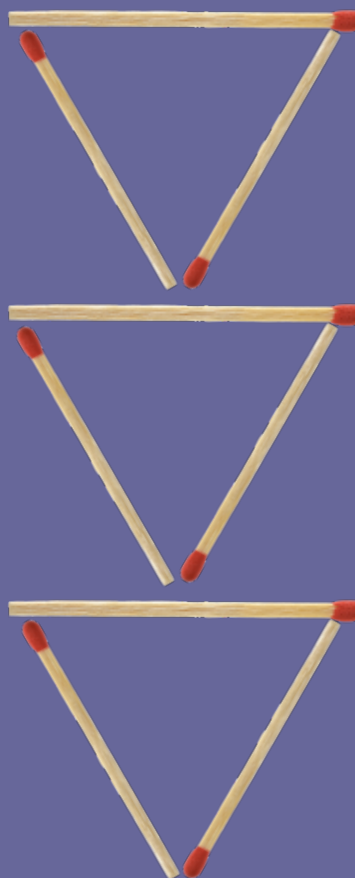

Move three matchsticks—no overlapping—to make four equilateral triangles

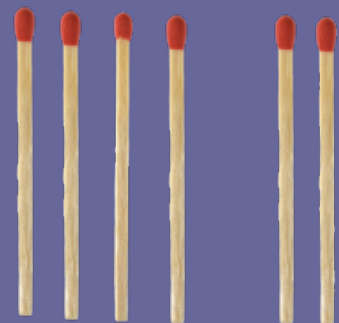

The current arrangement is 4-3-2-1. Move just one matchstick to change the arrangement

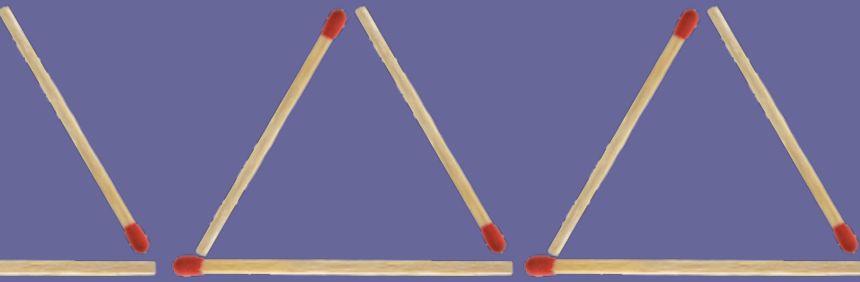

Move two matchsticks to form four triangles

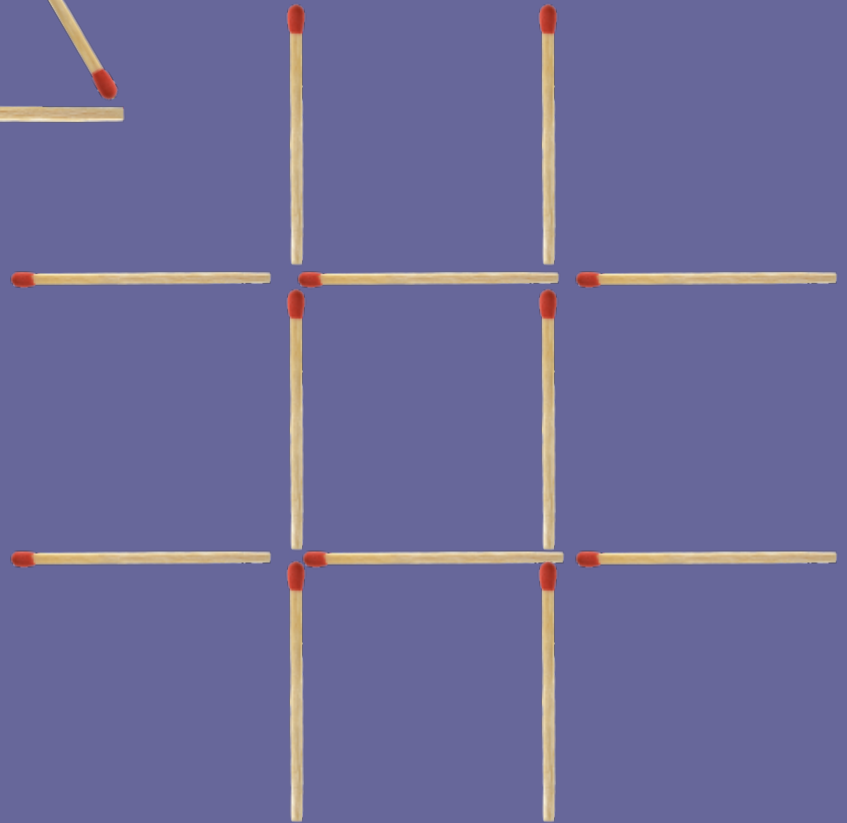

Move three matchsticks to make three squares

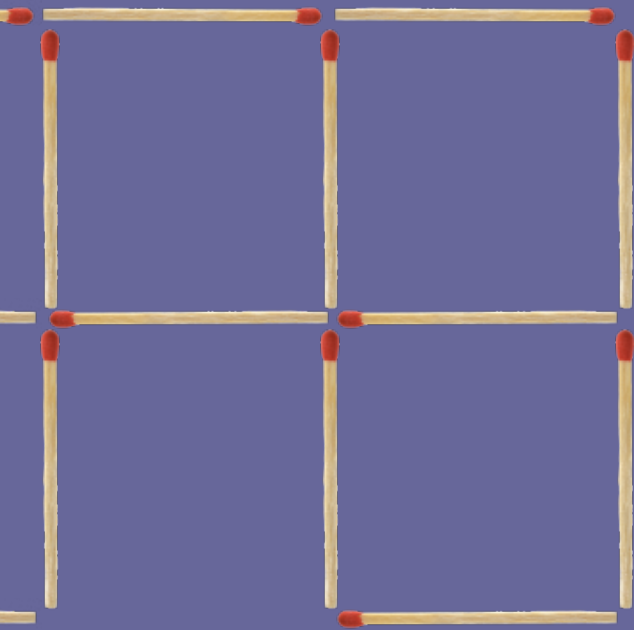

Move three matchsticks to make four squares

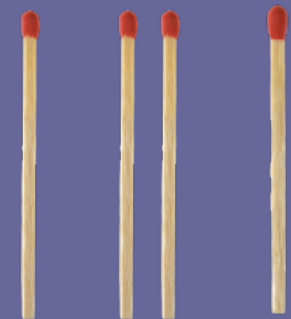

Move three matchsticks, left to right, to change the arrangement to 1-2-3-4.

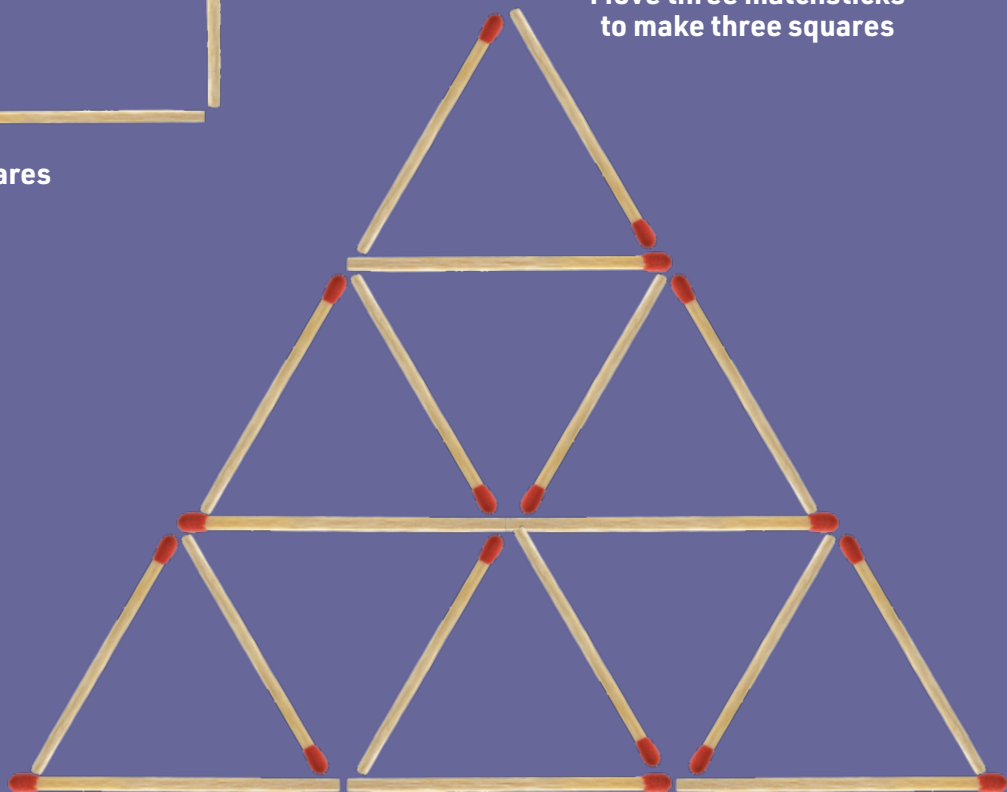

This arrangement forms thirteen triangles (nine small, three medium, one large). Remove three matchsticks to make four triangles.

# Fiber Optic Illustrated Glossary

**Amplifier** A device inserted within a transmission path that boosts the strength of an optical signal. Amplifiers can be placed just after the transmitter (power booster), between the transmitter and the receiver (in-line amplifier), or just before the receiver (preamplifier).

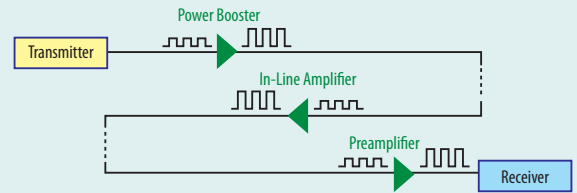

**APC** Abbreviation for Angled Physical Contact. A style of fiber optic connector with a 5° -15° angle on the connector tip for the minimum possible backreflection.

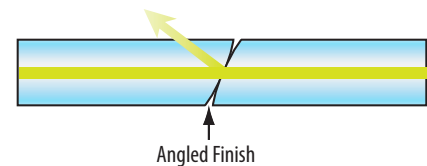

**Attenuation** Loss or decrease in power from one point to another in a fiber optic cable.

**Attenuation Limited Operation** The condition in a fiber optic link when operation is limited by the power of the received signal (rather than by bandwidth or by distortion). Attenuation is usually measured in decibels per kilometer (db/km) at a specific wavelength. The lower the number, the better the fiber.

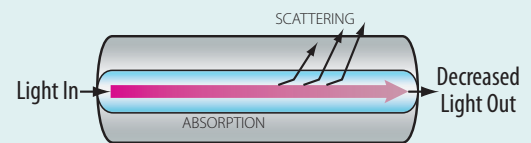

**Axis** The center of an optical fiber.

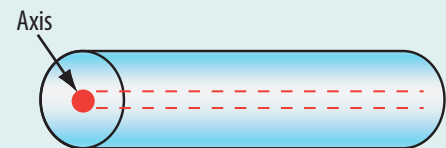

**Backreflection (BR)** A term applied to any process in the cable plant that causes light to change directions in a fiber and return to the source. Occurs most often at connector interfaces where a glass-air interface causes a reflection.

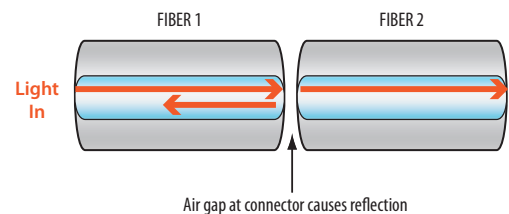

**Backscattering** The return of a portion of scattered light to the input end of a fiber; the scattering of light in the direction opposite to its original propagation.

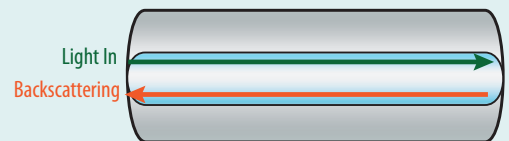

**Bandwidth** The information carrying capacity of an optical fiber, expressed in MHz/km. The measure is dependent upon wavelength and type of light source.

**Bandwidth Limited Operation** The condition prevailing when the system bandwidth, rather than the amplitude of the signal, limits performance. The condition is reached when modal dispersion distorts the shape of the waveform beyond specified limits.



**Bend Radius** Radius a fiber or fiber optic cable can bend before breaking or suffering increased attenuation.



**Buffer** A protective coating applied directly to the fiber.

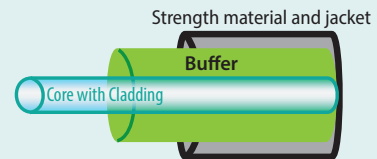

**Butt Splice** A joining of two fibers without optical connectors arranged end-to-end by means of a coupling. Fusion splicing is an example. Using an electric arc to weld two fiber optic cables together fusion splicing offers sophisticated, computer controlled alignment of fiber optic cables to achieve losses as low as 0.05 dB.

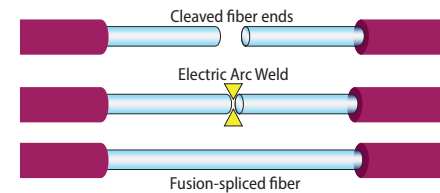

**Cladding** Material that surrounds the core of an optical fiber. Its lower index of refraction, compared to that of the core, causes the transmitted light to travel down the core.

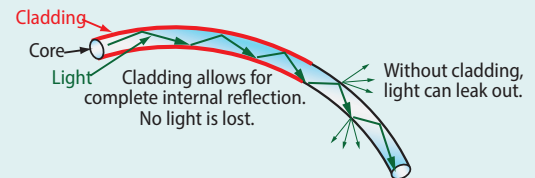

**Cleave** The process of separating an optical fiber by a controlled fracture of the glass, for the purpose of obtaining a fiber end, which is flat, smooth, and perpendicular to the fiber axis.

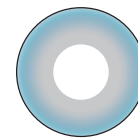

**Decibel (dB)** Unit for measuring the relative strength of a signal.

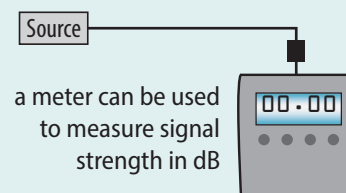

**Ferrule** A small tube or block designed to house and align optical fibers within the interconnect terminus. Generally made of stainless steel, ceramics, or polymer, the ferrule is used to confine and align the stripped fiber ends for efficient light transmission between connected fibers. MT ferrules are uniquely capable of housing multiple fiber lines in ultra high-density arrangements.

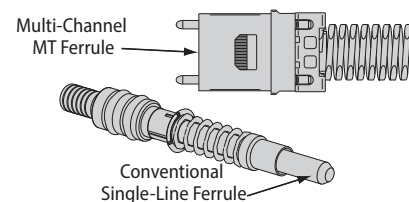

# Fiber Optic Illustrated Glossary *continued*

**Fresnel Reflection Loss** Reflection losses incurred at the input and output points of optical fibers due to the difference in refractive index between core glass and immersion media.

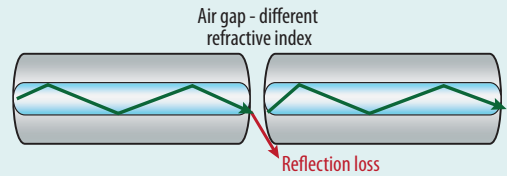

**Gap Loss** Loss resulting from the end separation of two axially aligned fibers.

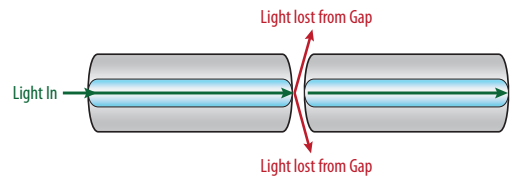

**GRIN** Abbreviation for GRAdient INdex. This type of multimode fiber uses a core in which the refractive index gradually decreases from the center of the fiber out toward the cladding. Light rays moving down the center axis advance more slowly than those near the edge, which take a helical curved path, shortening their travel distance. The faster rays at the edge of the fiber arrive closer together with the slower rays from the center, allowing for a signal with less dispersion.

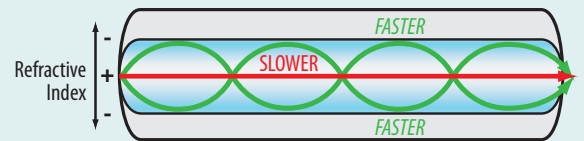

**Insertion Loss** Attenuation caused by the insertion of an optical component; in other words, a connector terminus or coupler in an optical transmission system.

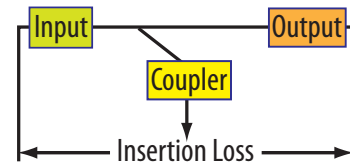

**Interferometer** An instrument that uses the principle of interference of electromagnetic waves for purposes of measurement. Used to measure a variety of physical variables, such as displacement (distance), temperature, pressure, and strain.



**Microbending** Mechanical stress on a fiber that introduces local discontinuities, which results in light leaking from the core to the cladding by a process called mode coupling.

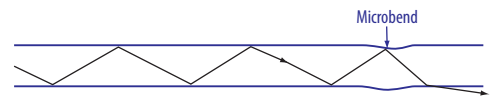

**Misalignment Loss** The loss of power resulting from axial misalignment, lateral displacement, and end separation.

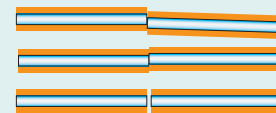

**Multimode (MM) Fiber** An optical fiber that has a core large enough to propagate more than one mode of light. The typical diameter is 62.5 micrometers.

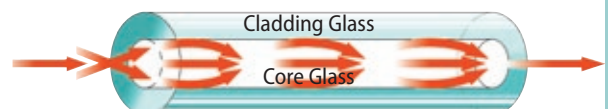

**Optical Time Domain Reflectometer (OTDR)** Testing system for fiber strands in which an optical pulse is transmitted through the fiber and the resulting backscatter and reflections are used to estimate attenuation and identify defects and the sources of localized losses.



**Single-mode (SM) Fiber** A small-core optical fiber through which only one mode will propagate. The typical diameter is 8-9 microns.

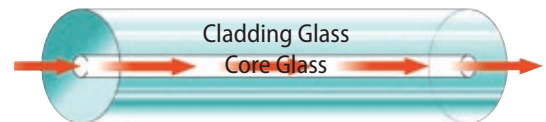

**Source** The means used to convert an electrical information-carrying signal to a corresponding optical signal for transmission by fiber. The source is usually a Light Emitting Diode (LED) or Laser housed inside an optical-to-electrical **transceiver** device (see Transmitter)



transceiver



source

**Tools** Fiber optic tools or tooling are essential to termination, assembly, inspection, and cleaning. Low-volume operations may use hand polishing, but higher-volumes require the use of automated polishing equipment. Other essential tools (supplied by Glenair) include inspection probes as well as dry and wet cleaning apparatus.



Dry-action cleaning tool

**Transducer** A device for converting energy from one form to another, such as optical energy to electrical energy.



**Transmission Loss** Total loss encountered in transmission through a system.



**Transmitter** An electronic package that converts an electrical signal to an optical signal.

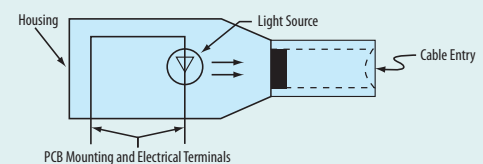

**Wavelength** The distance between successive peaks (or troughs) of a light wave as it travels through a fiber optic cable. Varying wavelengths are employed for transmitting optical data. Higher wavelengths such as 1550 nm are less susceptible to attenuation and can travel longer distances before experiencing significant signal loss.

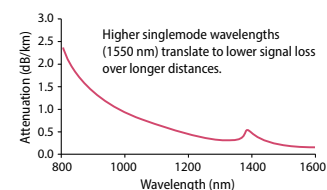

# BUYERS GUIDE: MIL-QUALIFIED AND GLENAIR SIGNATURE FIBER OPTIC CONNECTORS, CABLES, AND TERMINI



A complete range of rugged fiber optic interconnect systems optimized for each military service branch and/or harsh environment industrial application. Complete capability includes turnkey fiber optic cable assemblies, discrete connectors and termini, backshell accessories, and certification testing. All systems are designed, qualified, and made in our USA or UK factories.



Glenair signature MT ferrule connectors are the only ruggedized solution certified by US CONEC



The world's most complete offering of Mil-qualified and Glenair signature butt-joint, MT ferrule, and expanded-beam F/O systems

**SuperNine  
MIL-DTL-38999 Type**



**The go-to military/aerospace fiber optic/termini solution.** Glenair signature “better than QPL” SuperNine® series tight-tolerance connectors with superior termini axial alignment and low dB loss performance.

**ARINC 801  
Genderless**



**The ARINC 801 genderless size #16 rear-release termini for ARINC 801 and other industry-standard connector packages.** Ultra-low dB loss ARINC solution with removable alignment sleeve retainer for easy maintenance.

**Glenair High  
Density (GHD)**



**The Glenair High-Density size #18 genderless termini alternative to larger form-factor MIL-DTL-38999 fiber optic connectors.** For military/aerospace applications that require reduced size and weight in a D38999-type package.

**Series 806  
Mil-Aero Micro  
Miniature**



**The ultimate harsh-environment micro miniature butt-joint type fiber optic connection system.** Series 806 Mil-Aero meets all of the harshest SWAMP-zone aerospace requirements at half the size and weight of D38999.

**Rugged MT  
Fiber Optics**



**The highest-reliability, highest-density fiber optic connection system.** Glenair ruggedized MT ferrule solutions for I/O and backplane applications— aerospace-grade circular, rectangular, and VITA 66 packaging.

**NAVSEA and  
Underwater  
Oil & Gas**



**MIL-PRF-28876 qualified shipboard fiber optic connectors, termini, backshells, and assemblies.** In-stock, high-availability, Navy-approved fiber optics plus SeaKing high-pressure open-face, Pierside, and NGCON next-gen systems.

**Glenair Front  
Release (GFR)**



**The Glenair signature solution for rapid integration of fiber optic media in virtually any connector package.** Unique-design size #16 ferrule system with integrated termini retention and environmental sealing.

**Rugged Field  
and Expanded Beam  
Fiber Optics**



**Sealed, lens-array fiber optics for harsh environmental applications plus GFOCA hermaphroditic.** GFOCA is the industry-standard for long-run battlefield data links. Glenair signature Eye-Beam Power, Eye-Beam GMA, and Eye-Beam GLT are easiest-to-clean expanded beam designs.

**Termination  
and Inspection  
Tools and Kits**



**The right fiber optic tool for the job.** Industry-standard and Glenair signature installation and maintenance tooling, workstations, and kits for factory and field fiber optic termination and troubleshooting.

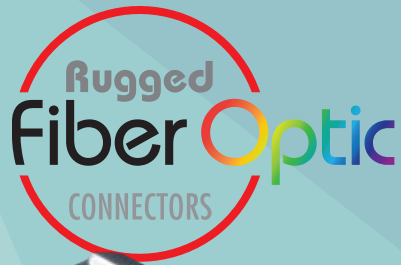

# SuperNine<sup>®</sup> Tight-Tolerance MIL-DTL-38999 Sr. III Fiber Optic Connection System



The high-performance MIL-DTL-38999 type fiber optic interconnect system with qualified MIL-PRF-29504/4 and /5 termini, successfully deployed in hundreds of commercial and military aerospace and other rugged applications—from F-16 upgrade systems to the revolutionary F-35 Joint Strike Fighter.



Terminated and tested point-to-point and multibranch D38999 type fiber optic cable assemblies

- Composite, aluminum and stainless steel shells available
- Qualified size #16 MIL-PRF-29504 /4 and /5 precision ceramic termini
- Singlemode and multimode fiber, from 9/125 to 1000 microns
- Ultra-low insertion loss, <.50dB typical
- From 2 to 37 Termini
- Plug and In-Line, Jam Nut and Square Flange Receptacles
- Patented MIL-DTL-38999 fiber optic test probes and adapters

## ABOUT MIL-DTL-38999 SERIES III TYPE FIBER OPTICS

Glenair's complete line of multi-channel MIL-DTL-38999 Series III Type fiber optic products includes qualified size 16 MIL-PRF-29504 /4 and /5 precision ceramic termini, and commercial large-core and jewel size 16 termini, as well as high-density size 20 termini. Tight-tolerance fiber optic connectors, backshells, and accessories IAW MIL-DTL-38999 Series III (Glenair SuperNine®) are available in metal and composite versions.



Plug



In-Line Receptacle



Jam-Nut Receptacle



Panel-Mount Receptacle

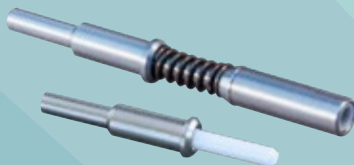

Glenair M29504/04 and /05 QPL termini are in stock and ready for immediate, same-day shipment

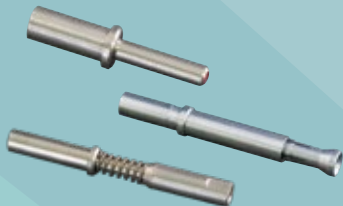

Large-core and jewel size #16 termini

- Glenair SuperNine 180-091 series IAW MIL-DTL-38999 Series III connectors, designed and optimized for use with optical termini
- Ultra-tight tolerance shell and cavity dimensions for precise axial alignment
- Wider master key dimension on plug connector for improved cavity alignment
- Ultra-lightweight composite thermoplastic connector solutions plus lightweight aluminum, rugged stainless steel and marine bronze
- Qualified size #16 MIL-PRF-29504 pin-socket precision ceramic termini
- Insert arrangements from 2 to 37 ways
- Advanced RoHS-compliant finish solutions
- IP68 in mated condition (10 meters, two hours)

| MATERIAL AND FINISH |                 |                           |
|---------------------|-----------------|---------------------------|
| Code                | Material        | Finish Description        |
| MA                  | Aluminum        | Electroless Nickel, Matte |
| ME                  |                 | Electroless Nickel        |
| MT                  |                 | Nickel-PTFE, Gray         |
| NF                  |                 | Cadmium, Olive Drab       |
| TZ                  |                 | Tin-Zinc, Green-Gold      |
| ZN                  |                 | Zinc-Nickel, Olive Drab   |
| ZNU                 |                 | Zinc-Nickel, Black        |
| ZR                  |                 | Zinc-Nickel, Black (RoHS) |
| XM                  | Composite       | Electroless Nickel        |
| XMT                 |                 | Nickel - PTFE, Grey       |
| XW                  |                 | Cadmium, Olive Drab       |
| XZN                 |                 | Zinc-Nickel, Black        |
| MS                  | Stainless Steel | Electroless Nickel        |
| ZL                  |                 | Electro-Deposited Nickel  |
| ZI                  |                 | Passivate                 |
| AB                  | Marine Bronze   | No Plating                |

| MIL-PRF-29504/04 AND /05 FIBER OPTIC TERMINI PERFORMANCE SPECIFICATIONS |   |
|---|---|
| Test Type   | Performance Requirement   |
| Optical Insertion Loss, Multimode (MM) *                                | 0.35 dB Typical (50/125 and 62.5/125), restricted launch                      |
| Optical Insertion Loss, Singlemode (SM) *                               | 0.30 dB Typical (9/125)   |
| Optical Return Loss   | Better than -40 dB - PC Polish<br>Better than -50 dB - Enhanced PC Polish     |
| Discontinuity, Vibration  | MM: 0.5 dB or more for 50 μs or more<br>SM: 0.5 dB or more for 50 μs or more  |
| Discontinuity, Shock  | MM: 0.5 dB or more for 50 μs or more<br>SM: 0.5 dB or more for 100 ms or more |
| Operating Temperature   | -55°C to +165°C (dependent on epoxy and cable)                                |
| Temperature (Thermal) Shock   | -55°C to +165°C, 5 Cycles   |
| Temperature Life  | +165°C, 1000 hours  |
| Mating Durability   | 500 cycles (cleaning after 100 matings)                                       |
| Vibration - Sinusoidal  | 60.0 Grms at ambient temperature. Monitored for Discontinuity.                |
| Vibration - Random at Temperature                                       | 41.7 Grms at 125°C. Monitored for Discontinuity.                              |
| Vibration - Random at Ambient   | 49.5 Grms at ambient temperature. Monitored for Discontinuity.                |
| Mechanical Shock (High Impact)  | Per MIL-DTL-901, grade A, type B, class I. Monitored for Discontinuity.       |
| Mechanical Shock (Half-Sine Pulse)                                      | 300 G Peak over 3ms duration. Monitored for Discontinuity.                    |

\* Optical Insertion Loss values when tested in Tight Toleranced Connectors

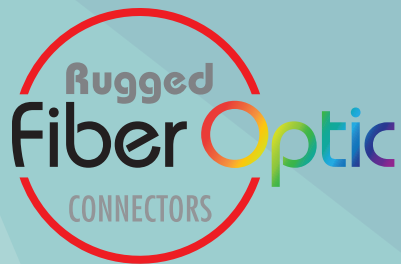

# Ultra-Low dB Loss ARINC 801 Fiber Optic Termini in Glenair Signature High- Performance Packaging



ARINC 801 is a keyed genderless fiber optic terminus used in a broad range of aerospace connector packages including ARINC 801, ARINC 600, and other circular and rectangular series. The Glenair solution includes features from our “Better than QPL” SuperNine<sup>®</sup> connector with improved axial alignment, vibration and shock resistance, and low dB loss performance. Loose structure and tight structure cable types are supported.

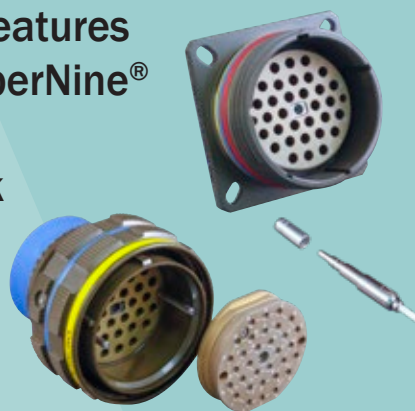

- Keyed, genderless terminus design eliminates pin and socket complexity and supports both PC and APC applications
- Rear-release size #16 termini (1.25mm ferrule)
- Singlemode (1310 and 1550 nm) as well as multimode (850 and 1300 nm)
- Mechanical and environmental performance in accordance with ARINC 801

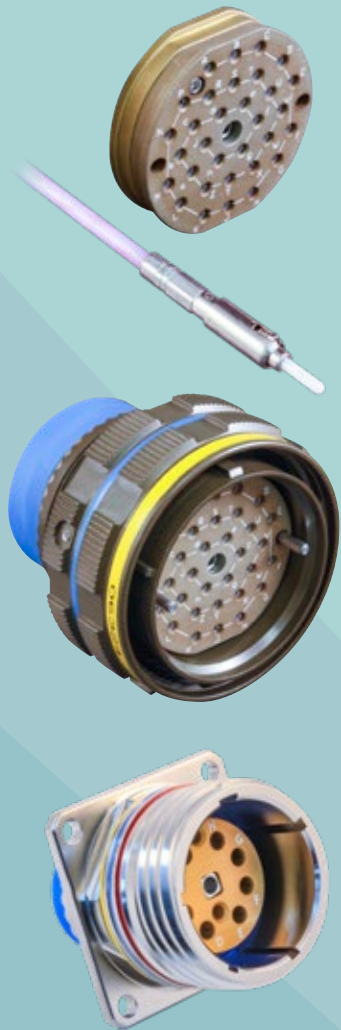

### ABOUT ARINC 801

ARINC 801 is an industry-standard terminus design for use in various form-factor aerospace connectors. Terminus features include Ø1.25mm precision zirconia ceramic ferrules and alignment sleeves, as well as a keyed body for angle polished (APC) end face termination. Connector features include removable alignment sleeve retainer and guide pins. Glenair offers singlemode (UPC and APC) as well as multimode (PC) options with familiar LC ferrule type termination. Terminus configurations available for use with loose and tight structure cable. A complete range of insert arrangements from 2 to 32 channels are available in accordance with ARINC 801. Glenair can provide connector packaging in virtually any supported format from ARINC 600 to EN4644. Our catalog solution incorporates "Better than QPL" MIL-DTL-38999 Series III type SuperNine® connector features (i.e. anti-decoupling and key polarization options).

| Series 180-159 ARINC 801 Performance Specifications |   |
|---|---|
| Test Description                                    | Performance Requirements/Specifications   |
| Insertion Loss                                      | Multimode (PC): 0.30 dB typical at 850/1300nm   |
|   | Singlemode (UPC): 0.30 dB typical at 1310/1550nm  |
| Return Loss   | Multimode (PC): Better than 20 dB   |
|   | Singlemode (UPC): Better than 40 dB   |
|   | Singlemode (APC): Better than 65 dB   |
| Operating Temperature                               | -55°C to +165°C (cable/epoxy dependent)   |
| Storage Temperature                                 | -40°C to +85°C (cable/epoxy dependent)  |
| Mating Durability                                   | 500 cycles, per TIA/EIA-455-21  |
| Vibration   | 23.1g RMS, 8 hrs/axis, per TIA/EIA-455-11, Test Condition VI-G                                      |
| Mechanical Shock (half-sine pulse)                  | 300g Peak for 3ms, 3 shocks/axis in each direction, per TIA/EIA-455-14, Test Condition D            |
| Thermal Cycling                                     | -55°C to +125°C, 50 cycles, per TIA/EIA-455-3, Test Condition C-4 (cable/epoxy dependent)           |
| Temperature Life                                    | +125°C for 1000 hrs, per TIA/EIA-455-4 (cable/epoxy dependent)                                      |
| Humidity, Steady State                              | +40°C for 240 hrs, 90% RH, per TIA/EIA-455-5, Method A, Test Condition B                            |
| Humidity, Temperature Cycling                       | -25°C to +65°C, 10 cycles for 24 hrs, 90% RH, per TIA/EIA-455-5, Method B7a (cable/epoxy dependent) |

### ARINC 801 INSERT ARRANGEMENTS

| MATERIAL AND FINISH |                 |                           |
|---------------------|-----------------|---------------------------|
| Code                | Material        | Finish Description        |
| ME                  | Aluminum Alloy  | Electroless Nickel        |
| MT                  |                 | Nickel-PTFE, Gray         |
| NF                  |                 | Cadmium, Olive Drab       |
| TZ                  |                 | Tin-Zinc, Green-Gold      |
| ZN                  |                 | Zinc-Nickel, Olive Drab   |
| ZR                  |                 | Zinc-Nickel, Black (RoHS) |
| XM                  | Composite       | Electroless Nickel        |
| XMT                 |                 | Nickel - PTFE, Grey       |
| XW                  |                 | Cadmium, Olive Drab       |
| XZN                 |                 | Zinc-Nickel, Black        |
| MS                  | Stainless Steel | Electroless Nickel        |
| ZL                  |                 | Electro-Deposited Nickel  |
| ZI                  |                 | Passivate                 |
| AB                  | Marine Bronze   | No Plating                |

CONNECTOR MASTER KEY



Shell Size 11  
Arrangement 2

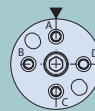

Shell Size 13  
Arrangement 4

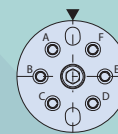

Shell Size 15  
Arrangement 6

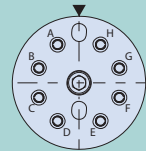

Shell Size 17  
Arrangement 8

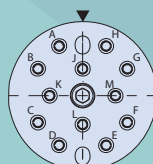

Shell Size 19  
Arrangement 12

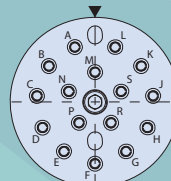

Shell Size 21  
Arrangement 16

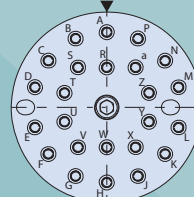

Shell Size 23  
Arrangement 24

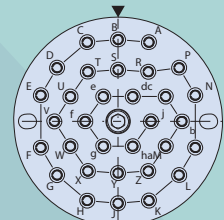

Shell Size 25  
Arrangement 32

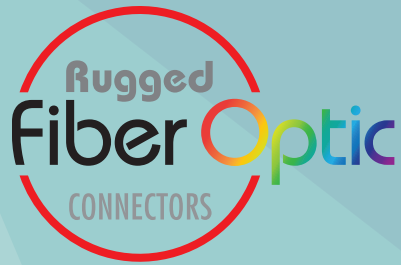

# Glenair High Density (GHD): Nearly Double the Density of Standard Mil-Spec Fiber Optic Designs



The system of choice for military and commercial air and space applications with aggressive size and weight requirements. Outstanding optical and environmental performance with nearly double the density of standard mil-spec, butt-joint solutions. Glenair High Density (GHD) is a complete fiber optic system with termini, connectors, cable and conduit assemblies, test probe adapters, tools, and more.

- Innovative #18 (1.25mm ferrule) front-release genderless termini accommodate 900 $\mu$  to 2.0mm jacketed fiber
- M85045/16 cable accommodation
- Composite, aluminum, or stainless steel shells with MIL-DTL-38999 mating and accessory threads
- Single key termini for APC polish available
- Better optical performance than D38999 with nearly double the density
- Precision alignment sleeve retainer with integrated guide pins



GHD plug connector with alignment sleeve retainer, and square flange receptacle. Termini available in keyed and non-keyed styles.



### ABOUT GLENAIR HIGH DENSITY (GHD)

The GHD fiber optic connection system is a D38999 workalike designed for applications that require higher-density fiber optic insert arrangements with the same outstanding optical and environmental performance as MIL-DTL-38999. The GHD system accommodates a broad range of singlemode and multimode fiber media and offers insertion loss values less than 0.5dB (typical loss for Glenair termini is 0.3 dB). Dense cavity spacing is achieved with an innovative Size 18 genderless front-release terminus design that provides nearly double the density as the standard M28876 and D38999 fiber optic connector series. The GHD system is also available with APC Angle Polish to reduce unwanted back reflection. A removable Alignment Sleeve Retainer (ASR) makes for easy fiber optic cleaning and maintenance in plug connectors. GHD is a complete system that includes keyed and unkeyed termini, a complete range of connector configurations, backshells, accessories, test probe adapters, tools, and more.

### GLENAIR HIGH DENSITY (GHD) FEATURES

| MATERIAL AND FINISH |                 |                           |
|---------------------|-----------------|---------------------------|
| Code                | Material        | Finish Description        |
| M                   | Aluminum Alloy  | Electroless Nickel        |
| MA                  |                 | Electroless Nickel, Matte |
| MT                  |                 | Nickel-PTFE, Gray         |
| NF                  |                 | Cadmium, Olive Drab       |
| TZ                  |                 | Tin-Zinc, Green-Gold      |
| ZNU                 |                 | Zinc-Nickel, Black        |
| ZR                  |                 | Zinc-Nickel, Black (RoHS) |
| XM                  | Composite       | Electroless Nickel        |
| XMT                 |                 | Nickel - PTFE, Grey       |
| XW                  |                 | Cadmium, Olive Drab       |
| XZN                 |                 | Zinc-Nickel, Black        |
| ZL                  | Stainless Steel | Electro-Deposited Nickel  |
| ZI                  | Steel           | Passivate                 |
| AB                  | Marine Bronze   | No Plating                |

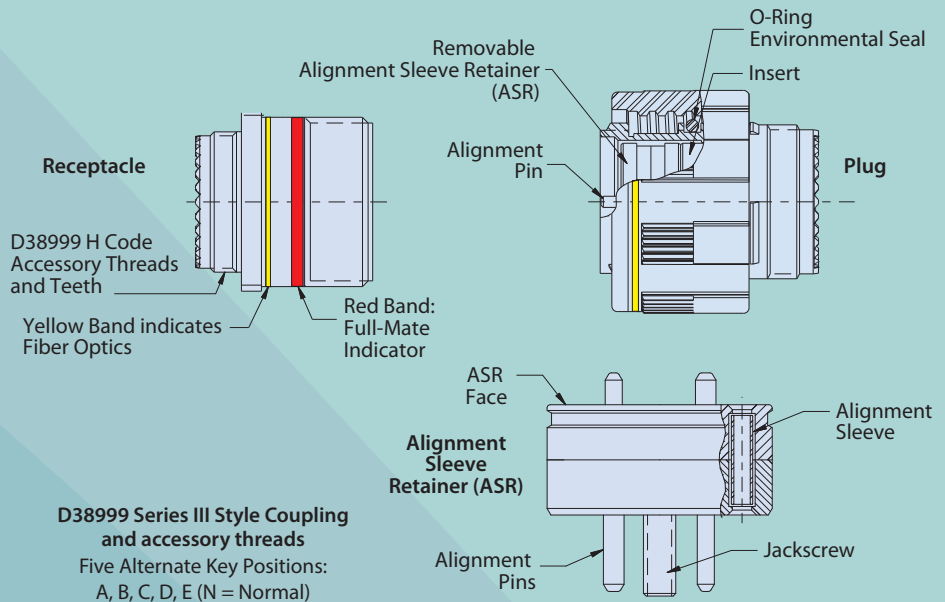

### COMPATIBLE D38999 SERIES III FIBER OPTIC BACKSHELLS AND ACCESSORIES



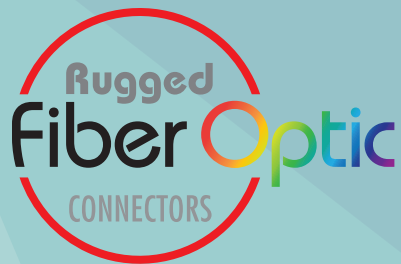

# Series 806 Mil-Aero: Reduced Size and Weight Micro 38999 Style Packaging, Ultra High-Density Size #20HD PC Termini



Innovative fiber optic / electrical connector design meets key performance benchmarks for harsh vibration, shock, and environmental settings in rigid conformance with MIL-DTL-38999 Series III—but at nearly half the size and weight.

## SAVE SIZE AND WEIGHT WITH SERIES 806 CONNECTORS

Series 806 Mil-Aero smallest shell (size 8)  
 .500 in. mating threads  
 3 Size #20HD electrical or optical contacts / termini



MIL-DTL-38999 smallest shell (size 11)  
 .750 in. mating threads  
 2 Size #16 electrical or optical contacts / termini

- Next-generation small form factor aerospace-grade circular connector
- High density 20HD fiber termini arrangements
- Designed for harsh application environments such as military and commercial aircraft
- Outstanding environmental, electrical, optical, and mechanical performance
- Integrated anti-decoupling technology
- High performance ceramic ferrule rear-release termini design



## ABOUT SERIES 806 MIL-AERO FIBER OPTIC

Glenair manufactures and supplies mil-qualified termini for use in MIL-DTL-38999 Series III type connectors including Glenair SuperNine, ARINC 801, and Glenair High Density (GHD). The Series 806 Mil-Aero is our highest density connector series built IAW D38999 Series III specifications—including vibration, shock, and high-altitude immersion. In fact, the Series 806 conforms to every MIL-DTL-38999 Series III standard requirement, but does so in a micro miniature reduced size and weight format, which now includes fiber optic configurations with size 20HD pin and socket termini. These ultra high density fiber optic termini are snap-in, rear release designs featuring precision ceramic ferrules and alignment sleeves for accurate fiber alignment. Typical insertion loss 0.5 dB. Fits 50/125 and 62.5/125 multimode and 9/125 singlemode fiber. Connectors are available with accessory thread or band shield termination porch for easy termination of optical media Kevlar strength member or EMI shielding (hybrid applications).

### SERIES 806 ARRANGEMENTS COMPATIBLE WITH #20HD FIBER OPTIC TERMINI

Mating face of pin connector. Socket numbering is reversed.

Symbol ▼ indicates master key location.

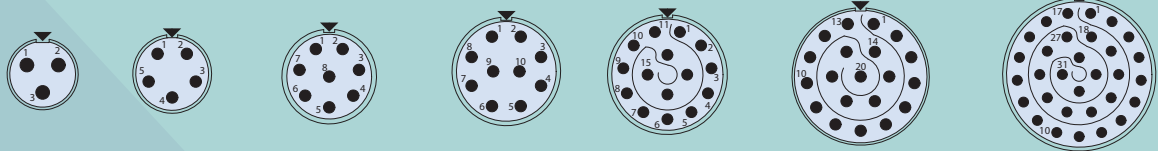

| Arrangement No. | 8-3 | 9-5 | 10-8 | 11-10 | 12-15 | 14-20 | 16-31 |
|-----------------|-----|-----|------|-------|-------|-------|-------|
| No. of Termini  | 3   | 5   | 8    | 10    | 15    | 20    | 31    |

## PLUG AND RECEPTACLES AVAILABLE WITH ACCESSORY THREADS OR SHIELD TERMINATION PORCH



Cable Plug



Square-Flange Receptacle



Jam-nut Receptacle



In-Line Receptacle

## 20HD FIBER OPTIC TERMINI FOR SERIES 806 MIL-AERO CONNECTORS



**Single or multimode. Ceramic ferrule. 0.5 dB loss.** Size 20HD fiber optic termini are compatible with Series 806 connectors with size 20HD contact arrangements. These snap-in, rear release termini feature precision ceramic ferrules and alignment sleeves for accurate fiber alignment. Typical insertion loss 0.5 dB. Fits 50/125 and 62.5/125 multimode and 9/125 singlemode fiber.

### MATERIAL/FINISH

- Ferrule, alignment sleeve: zirconia ceramic
- Body, shroud: copper/nickel/zinc alloy
- Spring (socket, not shown): SST/passivated
- Protective cover (socket): BeCu alloy/nickel plated

### HOW-TO-ORDER 20HD FIBER OPTIC TERMINI FOR SERIES 806 CONNECTORS

| Termini Type | Optical Fiber Type | Part Number                  | ØA Ferrule Hole | Fiber Size Core/Cladding |
|--------------|--------------------|------------------------------|-----------------|--------------------------|
| Pin          | Singlemode         | <a href="#">181-134-1255</a> | 125.5 microns   | 9/125                    |
| Pin          | Multimode          | <a href="#">181-134-126</a>  | 126.0 microns   | 50/125, 62.5/125         |
| Socket       | Singlemode         | <a href="#">181-135-1255</a> | 125.5 microns   | 9/125                    |
| Socket       | Multimode          | <a href="#">181-135-126</a>  | 126.0 microns   | 50/125, 62.5/125         |

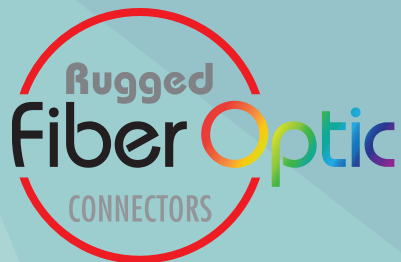

# Rugged High-Density PRIZM<sup>®</sup> MT Expanded Beam and MT Elite PC Fiber Optic Systems

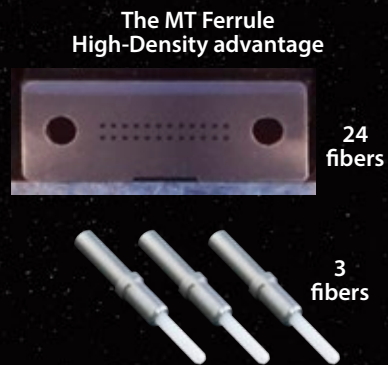

Easy-to-use, harsh environment, super high-density PRIZM<sup>®</sup> MT expanded-beam fiber optic assemblies in Glenair ruggedized I/O and backplane connector packaging

**ALSO AVAILABLE: MT ELITE<sup>®</sup> PHYSICAL CONTACT SINGLEMODE AND MULTIMODE CONNECTOR AND CABLE SOLUTIONS**

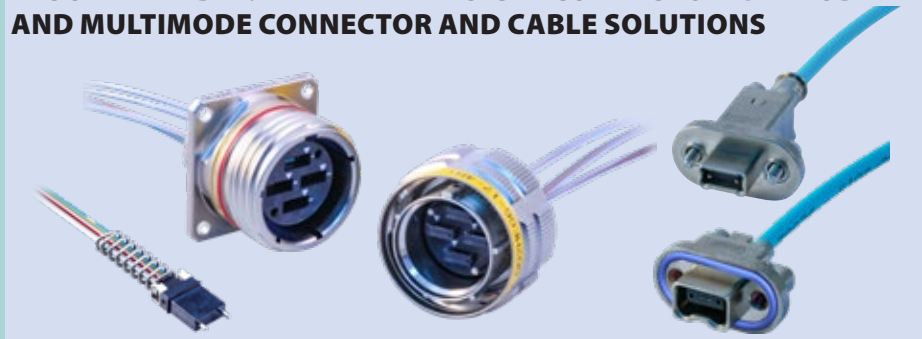

- Glenair is qualified by US Conec to terminate 1 and 2 row PRIZM<sup>®</sup> MT ferrules for ribbon and round cable fiber
- Turnkey, factory-terminated PRIZM<sup>®</sup> MT expanded beam assemblies—fully ruggedized for harsh air and space applications
- Reliable, repeatable optical performance
- Outstanding stability under shock and vibration conditions
- PRIZM<sup>®</sup> MT provides outstanding tolerance to debris contamination



Glenair US and UK are qualified by US Conec to terminate 1 and 2 row PRIZM® MT and ferrules for ribbon and round cable fiber

### ABOUT MT FERRULE FIBER OPTICS

PRIZM® MT is a monolithic optical fiber ferrule that integrates microlenses and mechanical alignment features into a single component. The design provides low insertion loss and return loss for up to 32 fibers and is optimally resistant to debris contamination. Glenair supplies the PRIZM MT ferrule in factory-terminated cable assemblies for both inside-the-box as well as environmental point-to-point applications. Ruggedized aerospace-grade I/O and backplane connectors are also available for use with standard MT Elite® physical contact (PC) ferrules. MT Elite compatible connectors and ferrule kits are ordered separately for complete convenience in the implementation of both singlemode and multimode fiber optic datalinks.

### SUPERNINE MT CONNECTOR CONFIGURATIONS



Cable Plug



In-Line Receptacle



Jam-Nut Receptacle

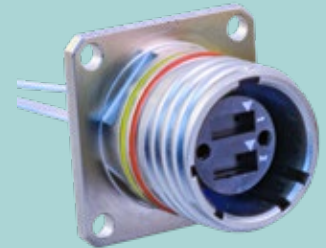

Panel-Mount Receptacles

### SERIES 79 MT CONNECTOR CONFIGURATIONS

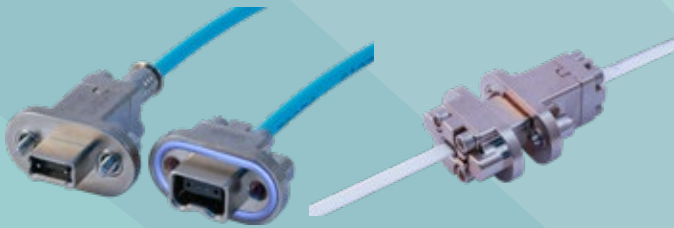

Plugs and receptacles with integrated banding porch, retaining plates, or EMI gasket for ribbon or round fiber media supporting both MT Elite® and PRIZM® MT ferrules.

### VITA 66 STYLE MT CONNECTORS

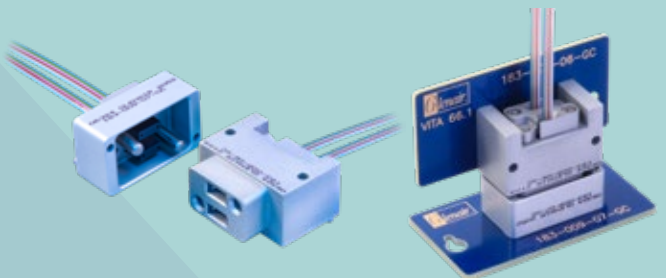

VITA 66.1 and 66.4 format. Discrete backplane connectors and MT ferrule assemblies.

### CATALOG FAST-TURNAROUND "ASAP" MT OPTICAL FLEX JUMPERS AND CABLE ASSEMBLIES

Glenair supplies—as a commercial off-the-shelf product—point-to-point optical flex jumpers with MT Elite and PRIZM MT optical ferrules. Available configurations include simple MT-to-MTP jumpers in straight or curved profiles, circular and rectangular I/O connectors with MT optical fiber pigtails, as well as special optical loop assemblies. A complete range of multimode and singlemode fiber in popular sizes, plus radiation-hardened fiber for earth orbit applications. Series 79- and SuperNine-to-MT ribbon fiber breakout cable assemblies are also available.

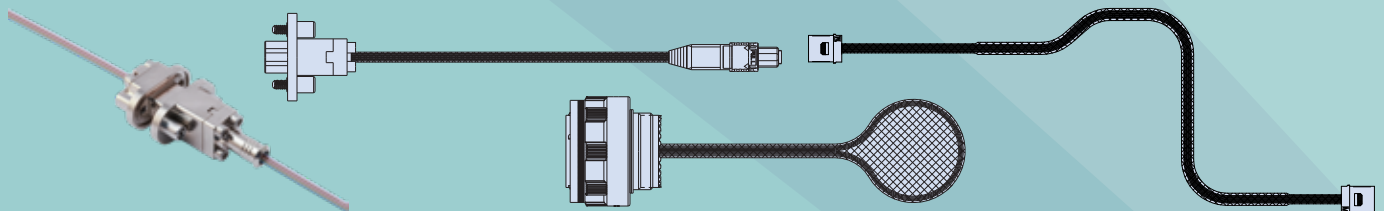

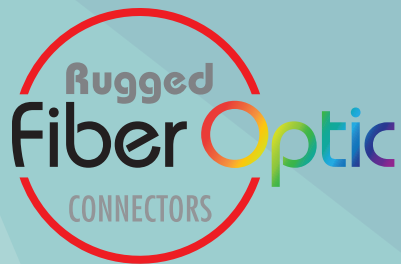

# NAVSEA and Underwater Oil & Gas Industry Fiber Optic Interconnect Systems



NAVSEA and commercial oil & gas industry qualified topside and subsea connectors. MIL-PRF-28876 and MIL-PRF-29504 /14 and /15 Navy F/O systems. Glenair signature SeaKing high-pressure, open-face subsea fiber optics. NGCON next-generation fiber optic system.

- M28876 connectors qualified to the complete requirements of MIL-PRF-28876
- All shell sizes and insert arrangements, including 2, 4, 6, 8, 18 and 31 channel layouts
- Qualified MIL-PRF-29504/14 and /15 pin and socket termini and /03 dummy terminus
- Glenair signature SeaKing underwater fiber optic connectors for oil & gas applications
- MIL-PRF-64266 (NGCON) next-generation shipboard / aerospace fiber optics

|  |  |  |
|--|--|--|
|  |  |  |
| <p>NAVSEA-qualified 28876 connectors and 29504 termini</p> | <p>Emerging NAVSEA next-gen NGCON fiber optics</p> | <p>10K PSI open-face SeaKing underwater fiber optics</p> |



**ABOUT GLENAIR NAVSEA AND UNDERWATER / OIL & GAS FIBER OPTIC INTERCONNECT SYSTEMS**

Qualified MIL-PRF-29504/14 and /15 termini and MIL-PRF-28876 connectors and backshells are ready for deployment in shipboard and submarine applications. NGCON MIL-PRF-62466 is a new rear-release fiber optic system designed for naval and airframe applications. SeaKing is a harsh-environment underwater 10K PSI open-face fiber optic system.

**QUALIFIED AND GLENAIR COMMERCIAL MIL-PRF-28876 FIBER OPTIC CONNECTORS AND MIL-PRF-29504 TERMINI—NAVY APPROVED, IN STOCK, AND READY FOR IMMEDIATE SHIPMENT**



Qualified QPL-29504 pin, socket, and dummy termini



Qualified M28876 environmental fiber optic connectors



Qualified M28876 backshells and accessories



Turnkey environmental and inside-the-box assemblies

**NGCON MIL-PRF-64266 NEXT-GENERATION FIBER OPTIC INTERCONNECT SYSTEM AND PIERSIDE FIBER OPTIC CONNECTORS IAW NAVSEA 737971 / 737972**



Rear-release genderless termini IAW M29504

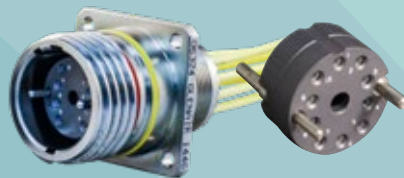

High-density receptacles and plugs with removable Alignment Sleeve Retainers for easy cleaning



Turnkey environmental and inside-the-box assemblies



**SEAKING™ FIBER OPTIC 10K PSI OPEN-FACE PRESSURE RATED FIBER OPTIC CONNECTORS, CABLES AND JUMPERS**



Environmental overmolded fiber optic jumpers

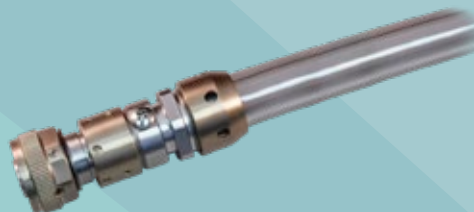

Pressure-balanced oil-filled (PBOF) high-pressure fiber optic assemblies

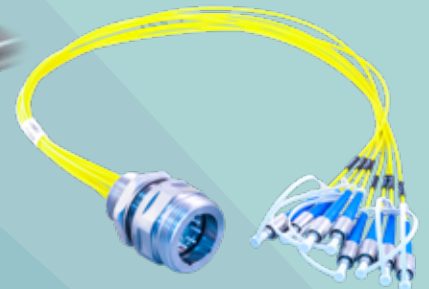

BCR or FCR to commercial fiber optic pigtail assembly for I/O-to-board module applications

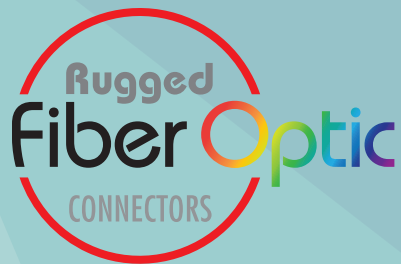

# Glenair Front Release (GFR) Fiber Optic Connection System: the Fast Road to Fiber Optic Integration

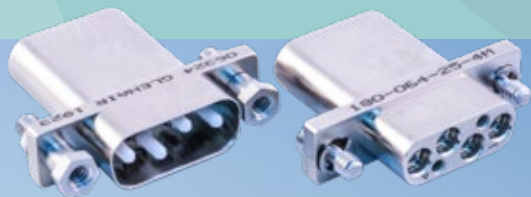

The Glenair Front Release system allows for rapid connector integration of optical media by placing retention and environmental sealing components directly on the termini. GFR enables fast design and development of unique fiber optic connector shell packages without costly tooling and engineering.

- Precision size 16 pin-socket front release termini with integrated retention clip
- Singlemode and multimode for all popular fiber sizes
- Typical insertion loss less than 0.5 dB
- Supports cylindrical and rectangular connectors
- Connector shells available in aluminum and stainless steel



GFR fiber optic termini integration in micro miniature rectangular and circular connector packaging

| MATERIAL/FINISH |                 |  |
|-----------------|-----------------|--|
| Code            | Material        | Finish   |
| <b>C</b>        | Aluminum Alloy  | Anodize, Black                                   |
| <b>M</b>        |                 | Electroless Nickel                               |
| <b>NF</b>       |                 | Cadmium, Olive Drab over Electroless Nickel      |
| <b>ZN</b>       |                 | Zinc-Nickel, Olive Drab, Over Electroless Nickel |
| <b>Z1</b>       | Stainless Steel | Passivate  |

### ABOUT GLENAIR FRONT RELEASE (GFR)

Glenair Front Release (GFR) fiber optic termini perform at insertion loss levels equivalent to the MIL-PRF-29504 termini designed for use in high-performance fiber optic systems such as MIL-DTL-38999 and MIL-PRF-28876. The GFR termini, however, feature integrated O-ring sealing and retention clips, making them suitable for easy integration into machined connector cavities in virtually any form-factor connector. This approach has enabled Glenair to integrate optical media—with ruggedized, low dB loss performance—in Micro-D, D-Subminiature, and any number of custom connector shells, both rectangular and cylindrical. Contact the factory for availability and application engineering assistance for both standard and custom GFR fiber optic applications.

### GFR FRONT-RELEASE TERMINI WITH INTEGRATED O-RING SEALING AND RETENTION CLIPS

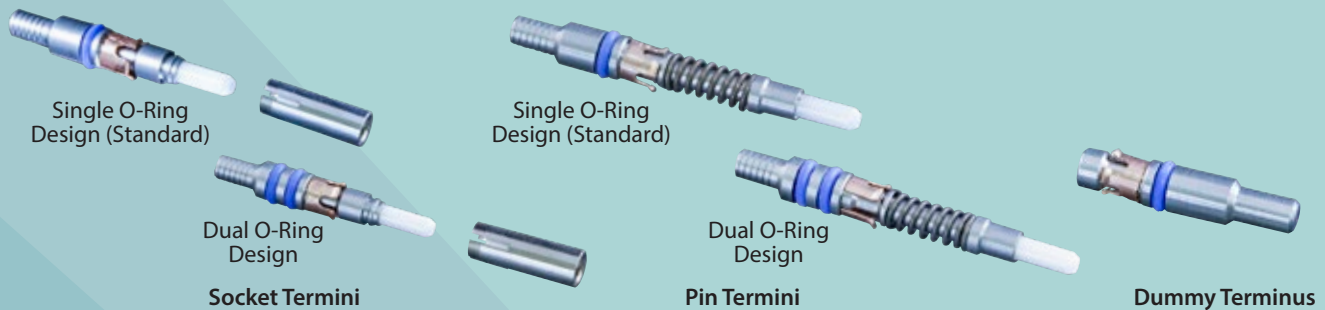

### MICRO-D FORM-FACTOR GFR CONNECORS



Support from one to eight GFR termini with insertion loss performance comparable to industry-standard MIL-PRF-29504. Precision-machined with integral alignment pins for optimum optical fiber alignment and low dB data loss performance. Available in aluminum and stainless steel. Termini sold separately. Support for single- and dual-O-ring termini. Panel cutouts IAW MIL-DTL-83513.

### D-SUBMINIATURE FORM-FACTOR GFR CONNECTORS



Support from four to twelve GFR termini with insertion loss performance comparable to industry-standard MIL-PRF-29504. Precision-machined with integral alignment pins for optimum optical fiber alignment and low dB data loss performance. Available in aluminum and stainless steel with standard jackpost hardware included. Termini sold separately. Support for single- and dual-O-ring termini. Panel cutouts IAW MIL-DTL-24308.

### MICRO-MINIATURE CIRCULAR GFR CONNECTORS



Support from two to twelve GFR pin or socket termini with insertion loss performance comparable to industry-standard MIL-PRF-29504. Precision-machined with O-ring environmental seal. Back-end threads and teeth accept Glenair Mighty Mouse accessories. Available in aluminum and stainless steel. Termini sold separately. Support for single- and dual-O-ring termini.

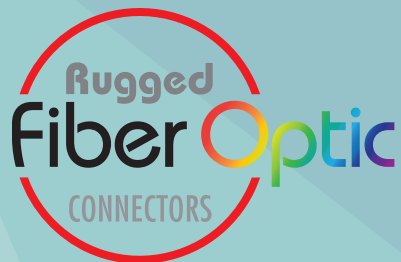

# Rugged Field and Expanded Beam Fiber Optics: Eye-Beam GLT, GMA, and Power Plus GFOCA D83526

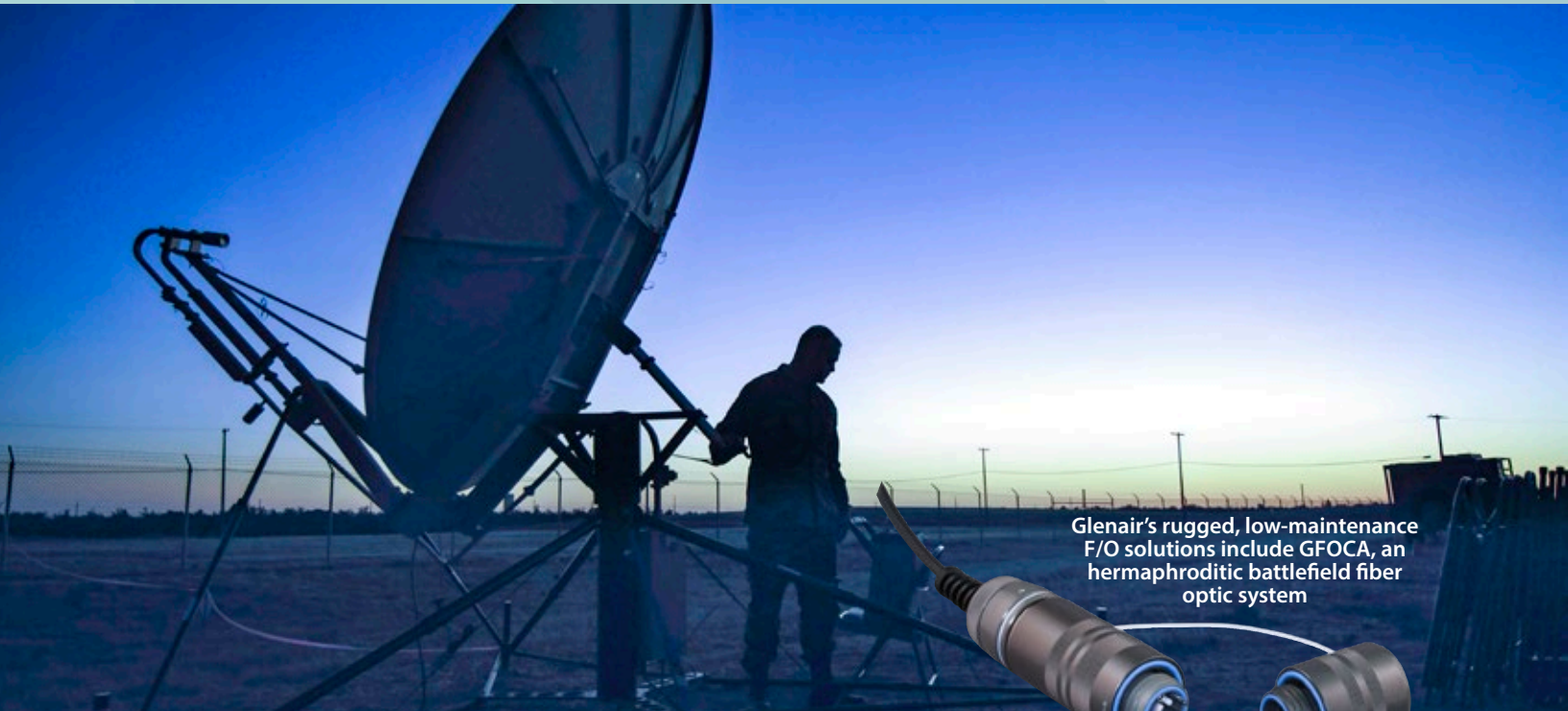

Glenair's rugged, low-maintenance F/O solutions include GFOCA, an hermaphroditic battlefield fiber optic system

Commonly used in harsh environmental applications such as directed energy weapons, long-run battlefield communications, and Free Space Optical applications, Glenair Expanded Beam fiber optics virtually eliminate field maintenance and cleaning difficulties, with low dB loss mating system performance rated to 1000-2000 cycles depending on fiber media selection.

## EXPANDED BEAM TECHNOLOGY

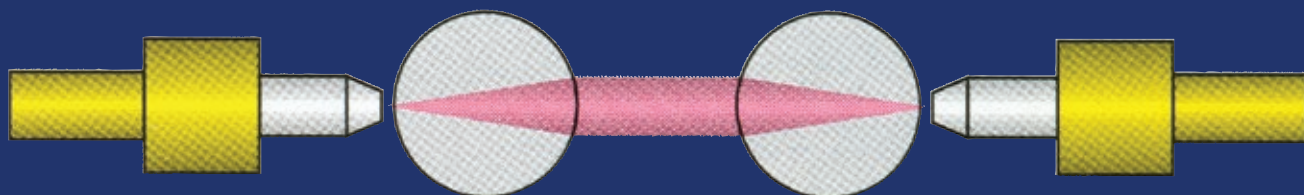

Expanded Beam connectors utilize a sealed lens to expand the emitting beam of light from the fiber media making connections less sensitive to alignment and contaminants. The expanded beam enters an air gap between connectors and is then refocused back into the fiber of the mating half. Sealed expanded beam assemblies are ideally suited for environmental applications where optical connectors are subject to repeated mating and unmating cycles. Easy to clean, terminate, and insensitive to contamination.



## ABOUT GLENAIR RUGGED FIELD AND EXPANDED-BEAM FIBER OPTICS

Eye-Beam GLT, Eye-Beam GMA, and Eye-Beam Power are optimized for reliable, low-maintenance performance in a wide range of ground/air applications. Eye-Beam GLT is a grin-lens terminus solution, Eye-Beam GMA is a workalike for the popular HMA hermaphroditic connector system, and Eye-Beam Power is a ruggedized, high optical power terminus design for directed energy and Free Space Optical applications. GFOCA hermaphroditic F/O interconnects are built IAW MIL-DTL-83526 and equipped with MIL-PRF-29504/16 type termini. The GFOCA is one of Glenair's most ruggedized field-deployable fiber optic platforms.

### INNOVATIVE EYE-BEAM GLT EXPANDED BEAM TERMINI DELIVER OPTIMAL PERFORMANCE IN HARSH ENVIRONMENTS

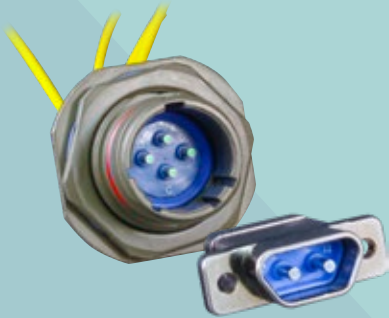

- All the benefits of an expanded beam connection system built into a versatile fiber optic terminus
- Factory-terminated Eye-Beam® GLT termini easily integrated into any connector package
- Innovative expanded beam lens terminus expands signal 27X from a standard 9.3 micron fiber core
- Revolutionary design delivers low dB loss performance (1.5 dB multimode, 2.0 dB singlemode untuned) while reducing maintenance, inspection and test costs
- Ultra-high precision ceramic sleeves and custom designed terminus bodies ensure axial alignment

### MIL-DTL-83526 HMA TYPE EYE-BEAM GMA BALL-LENS EXPANDED-BEAM FIBER OPTICS



- Field-deployable system for both indoor and outdoor applications
- Beam expansion dramatically reduces loss due to contamination
- Large ball lens facilitates easy cleaning
- Fully intermateable with all MIL-DTL-83526 /20 and /21 compliant connectors
- 2 and 4-channel insert arrangements
- Singlemode and multimode versions, plus broad support for a wide range of standard and tactical military cables

### EYE-BEAM POWER RUGGED, HIGH-POWER FIBER OPTICS FOR DIRECTED ENERGY AND FSO APPLICATIONS



- Size #8 drop-in expanded-beam optical contact
- Powerful 20W and higher optical contact ideally suited for directed energy applications
- Compatible with 1064nm polarization-maintaining fiber with a 0.5 dB typical insertion loss
- Low temperature rise at peak power
- Signature assembly process optimizes optical alignment for mission-critical reliability

### HARSH-ENVIRONMENT, FIELD-DEPLOYABLE GFOCA FIBER OPTIC CONNECTION SYSTEM

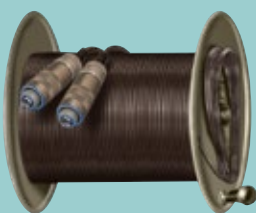

- Low insertion loss genderless termini
- 2.5 mm dia ceramic ferrules and alignment sleeves
- 4 channel singlemode and multimode configurations
- Designed to meet the requirements of MIL-PRF-29504/16 and MIL-DTL-83526 military specifications
- Discrete components or complete cable-on-reel solutions available

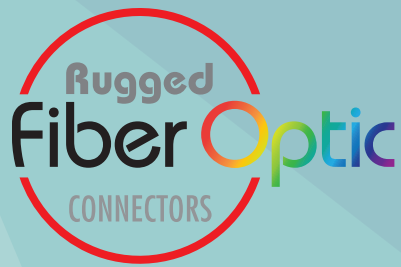

# Fiber Optic Termination, Inspection and Trouble-Shooting Equipment—Discrete Tools and Custom Kits

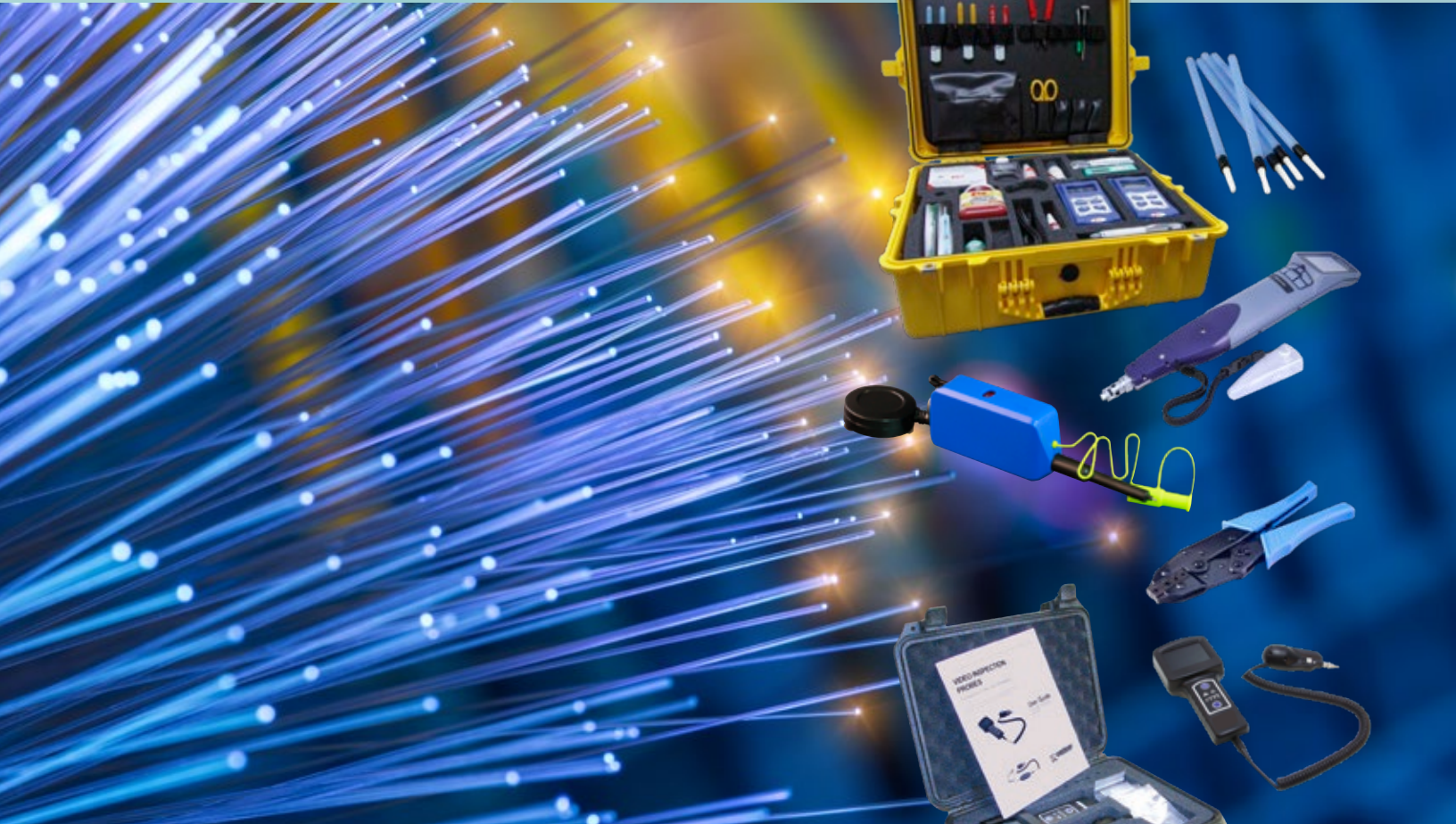

Our fiber optic termination, inspection, and cleaning kits—available in custom configurations from both our US and UK F/O operations—allow lab and field technicians to perform reliable assembly, inspection, and cleaning of fiber optic systems. Our termination kits, for example, are equipped with all the necessary tools—polishing pucks, jacket strippers, shears, scribes, dry-action cleaning tools, test probes and adapters, and more—everything required for ongoing termination and test of fiber optic systems.

- Comprehensive tooling for all Glenair fiber optic interconnect systems
- Discrete tools and bespoke kits. Everything from pin and socket polishing tools to jacket strippers, shears, scribes, inspection probes, and cleaning apparatus
- Inspection and testing instructions offer solutions to optical test and measurement

**THE RIGHT FIBER OPTIC TOOL FOR THE JOB**

Fiber optic connectors are designed to be connected and disconnected many times without affecting the optical performance of the fiber circuit. Optimal performance can be achieved by following the correct process for termination of the fiber line—a task which requires the use of highly-specialized tooling. Glenair's extensive experience in building fiber optic interconnect cables enables us to select the right tools for each step in the termination and assembly process, as well as optimal tooling for inspection, test, and cleaning. Our Fiber Optic Termination and Test Probe Kits allow field technicians the convenience of completing final termination of precision termini on site for easy and efficient cable routing and installation. Polishing tools are also sold separately for factory use or as replacement parts in field termination kits. Other specialty tools such as hand-held inspection monitors, dry- and wet-action cleaning tools are also available.

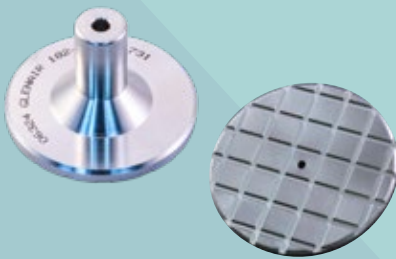

Polishing pucks

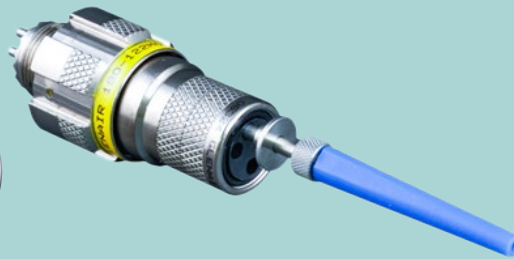

Test probes and adapters



Fiber optic test probe and adapter kits



Video bore scope inspection kits



Hand-held inspection monitor

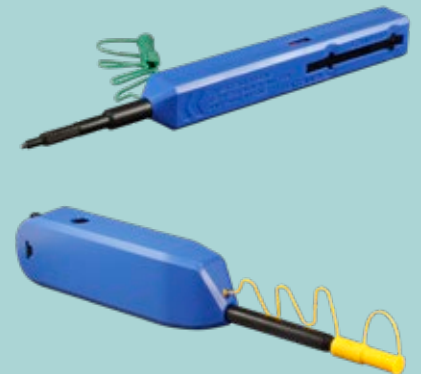

Dry-action cleaning tools



**GLENAIR FIBER OPTIC INSPECTION AND TESTING VIDEO INSTRUCTION**

For more information on Glenair's patented Fiber Optic Test Probe and Connector Adapter System and complete video instruction, visit our website at [www.glenair.com](http://www.glenair.com) or our youtube channel at [www.youtube.com/@Glenair](http://www.youtube.com/@Glenair). Other Glenair fiber optic video instruction covering such topics as fiber optic cleaning and testing, termini insertion and removal, cable preparation and assembly are also available on the site.

# Outlook

## Poor Charlie

American businessman, investor, and philanthropist Charlie Munger passed away this fall just one month shy of his 100<sup>th</sup> birthday celebration. "Celebration" is an apt word to use in the context of his death, as he was truly a man of fine parts—witty, capable, influential, and wise. His impact will be significant and lasting on the world he leaves behind.

A biography of Charlie's life would span many realms. But he was of course most famous for his life-long association and partnership with Warren Buffett at Berkshire Hathaway. In fact, the amazing compounding and growth of Berkshire's value over the decades is due in no small part to Charlie's sober approach to business and investing. "A great business at a fair price is superior to a fair business at a great price," sums up Charlie's model. Under his guidance, Berkshire invested in or acquired such top-drawer businesses as Coca-Cola, American Express, IBM, GEICO, See's Candies, and Wells Fargo.

Glenair Chairman and CEO Peter Kaufman had a long association and friendship with Charlie, one which on occasion brought the famous investor into our circle of life here in Glendale. Our MarCom team, under Peter's editorial direction, compiled and produced *Poor Charlie's Almanack: The Wit and Wisdom of Charles T. Munger*, arguably one of the most successful business books ever published. Recently re-released in an abridged format by Stripe Press, the timely compilation of Charlie's most impactful speeches and quotes will keep Charlie's ideas and models relevant and available for generations to come.

As described by Peter in his introduction to the book,

*"The quotes, talks, and speeches presented here are rooted in the old-fashioned Midwestern values for which Charlie has become known: lifelong learning, intellectual curiosity, sobriety, avoidance of envy and resentment, reliability, learning from the mistakes of others, perseverance, objectivity, willingness to test one's own beliefs, and many more. But his advice comes not in the form of stentorian admonishments; instead, Charlie uses humor, inversions (following the directive of the great algebraist, Jacobi, to 'invert, always invert'), and paradox to provide sage counsel about life's toughest challenges."*

Quite a few of us at Glenair have spent hours reading and re-reading *Poor Charlie's Almanack*, mining the volume for worldly wisdom. Here at the passing of this unique man's life, I can find no better tribute than to recommend the book to all of you. As Charlie was wont to say, "I have nothing to add."

*Chris Toomey*

# QwikConnect

GLENAIR • Volume 28 • Number 1

## Publisher

Christopher J. Toomey

## Managing Editor

Marcus Kaufman

## Art Director/Editor

Mike Borgsdorf

## Graphic Designer

George Ramirez

## Editor

Ryan O'Shea

Meghan Taylor

## Technical Consultant

Jim Donaldson

## Issue Contributors

Davinder Basuita

Mike Dabrowski

Monish Doshi

Jason LaRock

Pablo Medina

Indy Murillo

Greg Noll

Michael Too

Chris VanSoest

## Distribution

Terry White

To subscribe or unsubscribe,

please contact Terry White:

twhite@glenair.com

QwikConnect is published quarterly by Glenair, Inc. and printed in the U.S.A. All rights reserved. © Copyright 2024 Glenair, Inc. A complete archive of past issues of QwikConnect is available on the Internet at [www.glenair.com/qwikconnect](http://www.glenair.com/qwikconnect)

## GLENAIR, INC.

1211 AIR WAY  
GLENDALE, CA 91201-2497  
TEL: 818-247-6000  
FAX: 818-500-9912  
E-MAIL: [sales@glenair.com](mailto:sales@glenair.com)  
[www.glenair.com](http://www.glenair.com)

