



# QwikConnect

GLENAIR • APRIL 2019 • VOLUME 23 • NUMBER 2



**Interconnect Technologies  
You Need on Your Aircraft NOW**



## A “Systems Approach” to Aircraft Interconnect Cabling

Commercial aircraft manufacturers treat large, interdependent equipment sets as systems: avionics, galleys, cabin lighting, HVAC, IFE, navigation, and so on. The systems are designed with performance benchmarks tied to the environmental stress factors of the different zones of the aircraft where they are used. The cables and harnesses that interconnect these equipment sets, the *Electrical Wiring Interconnect System* (EWIS), is also now treated as a discrete system within the aircraft, subject to different requirements and specifications depending on the zones where it is located. In the past, the EWIS was treated more as an afterthought, with insufficient consideration given to best-practice design and zone-by-zone performance standards. The FAA, with the support of the principal aircraft manufacturers, has over the last several decades taken steps to change how interconnect technology is specified and managed. The key element of this effort was the move to treat wiring and associated interconnect components as a discrete system in its own right. The Electrical Wiring Interconnection System is now defined as: any wire, wiring device, or combination, including termination devices, installed in any area of the airplane, used to transmit electrical energy between two or more intended termination points.



## EWIS Performance

Historically, wiring and interconnect components were installed in aircraft in a “fit and forget” manner—without sufficient thought given to different aging and degradation impacts on a zone-by-zone basis. While the FAA has always outlined the top-level variables in EWIS degradation including aging, physical properties, installation and environment, and maintenance, cleaning and repair, it is only recently that these environmental stress factors have been exactly evaluated according to aircraft zones. Service history shows it is not just the manner by which EWIS is installed that directly affects degradation, but more importantly material choices, environmental sealing components, EMC shielding technologies and so on that are geared for the unique stress factors found throughout the aircraft. Today’s EWIS designers use *DO-160 Environmental Conditions and Test Procedures for Airborne Equipment* to ensure every element of the Electrical Wiring Interconnect System meets or exceeds requirements for vibration, shock, ground survival temperature, pressure differential, operating temperature, and moisture in each specific zone of the aircraft.

## Designing, Installing and Repairing EWIS

Many factors identified by the FAA must be considered when designing, installing or repairing an Electrical Wire Interconnect System, as follows:

## Electrical Load Determination

System designers must ensure that each aircraft electrical bus can safely support the load based on the electrical capacity of the aircraft’s electrical generators and distribution system. All electrical devices must be safely controlled or managed by the aircraft’s electrical system, and whenever a device is added, a load analysis should be performed to ensure that the new load on the bus can be powered adequately.

## Wire Selection: Size, Substrate, Plating, and Insulation

Wires should be sized so that they have sufficient mechanical strength, do not exceed allowable voltage drop levels, are protected by circuit protection devices, and meet circuit current-carrying requirements. Small gauge wires should use high-strength alloy conductors and additional support at terminations (grommets, shrink sleeves, etc.) to minimize fatigue. Wires should be plated to defend against surface oxidation. Elevated temperature degradation of tin- and silver-plated copper conductors will occur if they are exposed to continuous high-temperature operation.

While there is no “perfect” insulation system for aerospace wire and cable, the EWIS designer must consider the best balance of properties (electrical, mechanical, chemical, and thermal) for each application.

## Determining Current-Carrying Capacity

EWIS designers must verify that the maximum ambient temperature wire bundles will be subjected to, plus the temperature rise due to wire current loads, does not exceed the maximum conductor temperature rating. In smaller harnesses, the allowable percentage of total current may be increased as the harness approaches the single wire configuration. Care should be taken to ensure that the continuous current value chosen for a particular system circuit does not create hot spots within any circuit element which could lead to premature failure.



## Causes of EWIS Degradation

**Vibration:** High-vibration areas tend to accelerate degradation over time, resulting in “chattering” contacts and other intermittent problems. It can also cause tie-wraps to damage insulation, and exacerbate insulation cracking.

**Moisture:** High-moisture zones accelerate corrosion of interconnect components. EWIS installed in clean, dry areas with moderate temperatures hold up well.

**Maintenance and repair:** Improper maintenance techniques can contribute to EWIS degradation—for example, leaving metal shavings or debris behind after a repair. Wire bundles and connectors should be protected during modification work, and all debris must be cleaned up after work is completed. Generally, EWIS left undisturbed will have less degradation than reworked EWIS. As EWIS become more brittle with age, this effect becomes more pronounced. Repairs that conform to manufacturer’s recommended maintenance practices are generally considered permanent and should not require rework if properly maintained.

**Indirect damage:** Events such as pneumatic duct ruptures can cause damage that, while not initially evident, can later cause EWIS problems. When such an event has occurred, surrounding EWIS should be carefully inspected to ensure no damage is evident.

**Chemical contamination:** Chemicals such as hydraulic fluid, fuel, waste system chemicals, cleaning agents, deicing fluids, and even soft drinks can contribute to EWIS degradation. EWIS in the vicinity of these chemicals should be inspected for damage or degradation. Hydraulic fluids, for example, are very damaging to connector grommet and wire bundle clamps, and can lead to indirect damage such as arcing and chafing. EWIS components potentially exposed to hydraulic fluid should be given special attention during inspections.

**Heat:** High heat can accelerate degradation, insulation dryness, and cracking. Even low levels of heat can degrade EWIS over long periods of time. This type of degradation can be seen on engines, in galleys, and behind lights.

**Improper installation:** Improper installation can accelerate degradation. Improper routing, clamping, and terminating during initial installation or during modifications can lead to EWIS damage. FAA policy states that installation and routing instructions should be completely defined in detail to allow repeatability of installation, not leaving installation to the discretion of the installer.



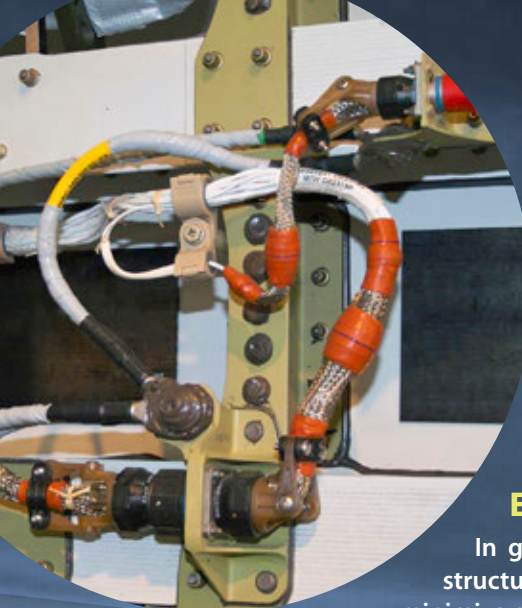

### Wire Substitution for Repairs and Maintenance

EWIS manufacturers are required to perform rigorous qualification testing of wires. The original aircraft manufacturer (OAM) may have special concerns regarding shielding and insulation for certain wiring that performs critical functions, or wiring chosen based on a set of unique circumstances. It is important to review the aircraft maintenance manual or contact the OAM when wire replacement is required.

### EWIS Routing

In general, EWIS should be routed and positioned to avoid chafing against aircraft structure or other components, to eliminate or minimize use as a handhold or support, to minimize exposure to damage by maintenance crews or shifting cargo, and to avoid exposure to corrosive fluids. Extra wire length should be supplied to allow for at least two re-terminations.

EWIS components must be protected in wheel wells and other areas where they may be exposed to damage from impact of rocks, ice, mud, etc.

Where practical, EWIS should be routed above fluid lines. Wires and cables routed within 6 inches of any flammable liquid, fuel, or oxygen line should be closely clamped and rigidly supported. The compression clamps should be spaced so that if there is a wire break, the broken wire will not contact hydraulic lines, oxygen lines, pneumatic lines, or other equipment whose subsequent failure caused by arcing could cause further damage.

For all types of wire breakouts—"Y," "T," and complex multi-branch—there should be sufficient slack in the breakout wires to avoid strain. Care should be taken when plastic tie wraps are used so that the tie wrap head does not cause chafing damage to the wire bundle at the breakout junction.

The EWIS design should preclude wire bundles from contacting the aircraft structure, using stand-offs to maintain clearance. Employing tape or protective tubing as an alternative to stand-offs should be avoided.

### Clamping and cable ties

Clamps and cable ties must be constructed of appropriate materials for their installation environment. Clamps must be properly sized for their wire bundles, snug enough to prevent free movement and chafing, and not used where their failure could result in interference with crucial aircraft controls or movable equipment. Clamps must be installed with their attachment hardware positioned above them so they are unlikely to rotate as the result of wire bundle weight or wire bundle chafing. Wire bundles need to be routed perpendicular to clamps. Appropriate slack needs to be maintained between clamps to protect the wires from stress while keeping the bundle free from contacting the structure. Also, sufficient slack should be left between the last clamp and the termination or electrical equipment to prevent strain at the terminal.

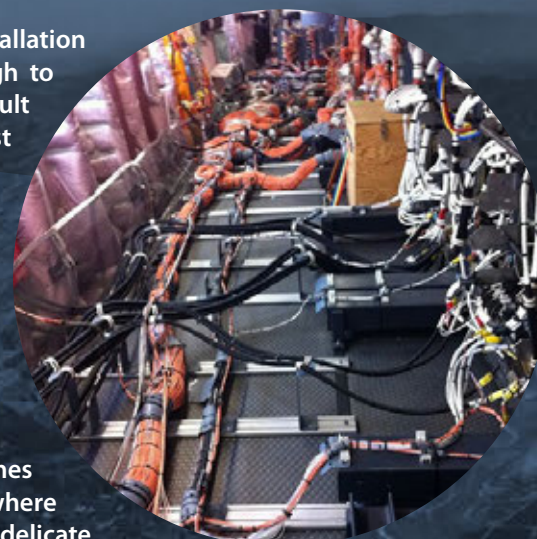

### Wire Bend Radii

The minimum radii of bends in wire groups or bundles must not be less than 10 times the outside diameter of the largest wire or cable, except that at the terminal strips where wires break out at terminations or reverse direction in a bundle. The bend radius for delicate thermocouple wire is 20 times the diameter, and for RF cables (e.g. coaxial and triaxial) is no less than 6 times the outside diameter of the cable.

### Unused Wires and Excess Wire

Ensure unused wires are individually dead-ended, tied into a bundle, and secured to a permanent structure. Each wire should have strands cut even with the insulation and a pre-insulated closed end connector or a 1-inch piece of insulating tubing placed over the wire with its end folded back and tied.

Coil and stow methods are often used to secure excess length of a wire bundle or to secure unconnected spare bundles. The wire bundle must be secured to prevent excessive movement or contact with other equipment that could damage the EWIS. Coil and stow in medium and high vibration areas requires additional tie straps, sleeving, and support.

### Wire Splicing

Improperly crimped splices can cause increased resistance, leading to overheating. Splicing should be kept to a minimum and avoided in high-vibration areas. Splicing of power wires, co-axial cables, multiplex bus, and large gauge wire should be avoided. Self-insulated splice connectors and environmentally-sealed AS7928 conformant splices are preferred. Splices should be located to permit inspection, and splices in bundles should be staggered so as to minimize any increase in the size of the bundle.

### Grounding and Bonding

One of the more important factors in the design and maintenance of aircraft electrical systems is proper bonding and grounding—the process of electrically connecting conductive objects to a conductive structure or return path to complete a circuit. Inadequate bonding or grounding can lead to unreliable operation of systems, damage to sensitive electronics, shock hazard, or lightning strike damage. The design of the ground return circuit should be given as much attention as the other leads of a circuit.

Low impedance paths to aircraft structure are normally required for electronic equipment to provide radio frequency return circuits, and for most electrical equipment to facilitate EMI reduction. Component cases producing electromagnetic energy should be grounded to the structure.

All conducting objects on the exterior of the airframe must be bonded through mechanical joints, conductive hinges, or bond straps capable of conducting static charges and lightning strikes.

### EWIS Identification

The proper identification of EWIS components with their circuits and voltages is necessary to provide safe operation and ease of maintenance. Each wire and cable should be marked with a part number and CAGE code so that it can be identified as to its performance capabilities, preventing the inadvertent use of lower performance and unsuitable replacement wire. Unmarked cables are more likely to be reconnected improperly which could cause numerous problems.

### Best Practices for EWIS

The number and complexity of EWIS has resulted in an increased use of electrical connectors for flexibility and modular replacement of electronic equipment. The proper choice and application of connectors is a significant part of the aircraft EWIS system. Connectors should be selected and installed to provide maximum safety and reliability to the aircraft.

- The connector used for each application should be selected only after a careful determination of the electrical and environmental requirements. Consider the size, weight, tooling, logistic, maintenance support, and compatibility with standardization programs.
- For ease of assembly and maintenance, connectors using crimped contacts are generally chosen for all applications except those requiring a hermetic seal.
- Proper insertion and extraction tools should be used to install or remove wires from connectors.
- Connectors susceptible to corrosion may be treated with a chemically inert waterproof jelly, or an environmentally-sealed connector may be used.
- Moisture-proof connectors should be used in all zones of the aircraft, including the cabin. Service history indicates that most connector failures occur due to some form of moisture penetration. Even in the pressurized, environmentally-controlled zones of the cockpit and cabin, moisture can occur due to condensation.
- Consideration should be given to the design of the pin arrangement to avoid situations where pin-to-pin shorts could result in multiple loss of functions and/or power supplies.







## COMMERCIAL AIRCRAFT

# Electrical Wiring Interconnect Systems

## Aircraft Zones and Glenair Signature Series Interconnect Technologies

This interconnect design and application guide is broken down into traditional aircraft zones as defined in RTCA/DO-160. Interconnect technology for individual sections and equipment-sets within each zone is presented in enough detail to enable EWIS designers to understand the broad range of options available and make sound specifications within each area of responsibility. Leveraging the talents of EWIS engineer Bob Johnson, Glenair has developed a number of Signature interconnect technologies for commercial aircraft, which are presented in the context of each zone.

AIRCRAFT ZONES:
1. Fuselage
2. Instrument Panel Console and Equipment Rack
3. Nacelle and Pylon
4. Engine and Gear Box
5. Wing and Wheel Well
6. Landing Gear
7. Empennage and Vertical Stabilizer Tip
8. Cabin interior volume

To assist designers in the specification of appropriate interconnect components for use in each zone, each spread in this document presents applicable "DO-160 Environmental Conditions and Test Procedures for Airborne Equipment," and the Glenair interconnect technologies that meet or exceed these requirements. As application guidelines for key environmental stress factors including vibration, shock, ground survival temperature, pressure differential, operating temperature, and moisture can change with each zone, only those applicable specification references are noted.

### CATALOG VERSUS CUSTOM / TAILORED TECHNOLOGIES

This design guide primarily presents proven-performance electrical interconnect technologies that can be sourced directly from catalog offerings. This includes the Bob Johnson signature series technologies which are highlighted for each zone. Designers looking to resolve long-standing problems or improve performance in such areas as size, weight, and power frequently turn to custom / tailored solutions. In both events, selections must be aligned with Federal Aviation Administration 14 CFR 25.1701 which states that EWIS components must be of a kind and design appropriate to its intended function and perform the function for which it was intended without degrading the airworthiness of the airplane. Responsibility for these determinations resides with the aircraft manufacturer.

### DO-160, ENVIRONMENTAL CONDITIONS AND TEST PROCEDURES FOR AIRBORNE EQUIPMENT AND AIRCRAFT ZONES

Effective EWIS design is best accomplished by aligning DO-160, Environmental Conditions and Test Procedures for Airborne Equipment, with the empirical environmental performance levels targeted for each zone, section, and equipment set on the aircraft.

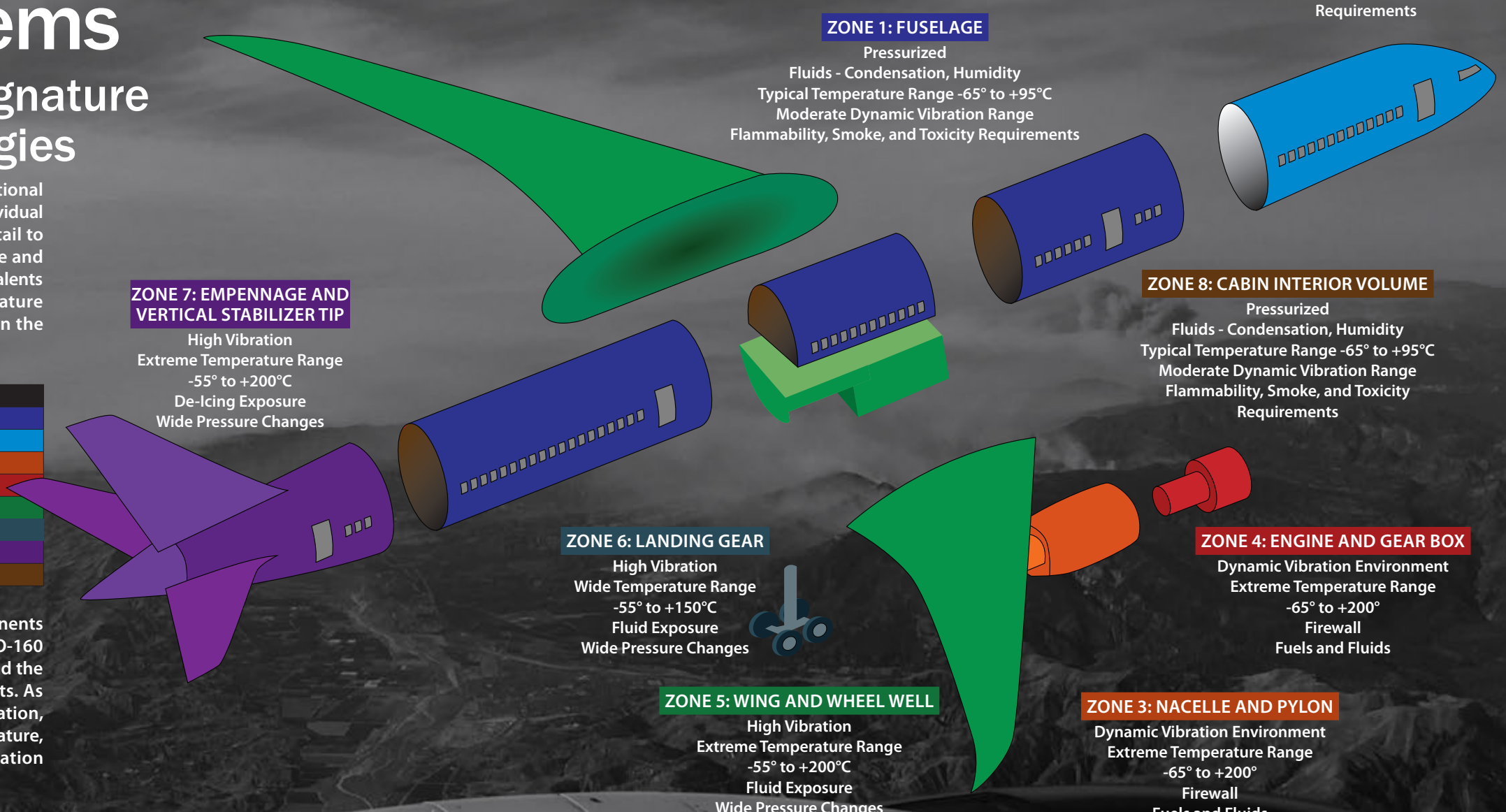

#### ZONE 1: FUSELAGE

Pressurized  
Fluids - Condensation, Humidity  
Typical Temperature Range -65° to +95°C  
Moderate Dynamic Vibration Range  
Flammability, Smoke, and Toxicity Requirements

#### ZONE 2: INSTRUMENT PANEL, CONSOLE, AND EQUIPMENT RACK

Pressurized  
Fluids - Condensation, Humidity  
Typical Temperature Range -65° to +95°C  
Moderate Dynamic Vibration Range  
Flammability, Smoke, and Toxicity Requirements

#### ZONE 8: CABIN INTERIOR VOLUME

Pressurized  
Fluids - Condensation, Humidity  
Typical Temperature Range -65° to +95°C  
Moderate Dynamic Vibration Range  
Flammability, Smoke, and Toxicity Requirements

#### ZONE 7: EMPENNAGE AND VERTICAL STABILIZER TIP

High Vibration  
Extreme Temperature Range  
-55° to +200°C  
De-Icing Exposure  
Wide Pressure Changes

#### ZONE 4: ENGINE AND GEAR BOX

Dynamic Vibration Environment  
Extreme Temperature Range  
-65° to +200°  
Firewall  
Fuels and Fluids

#### ZONE 6: LANDING GEAR

High Vibration  
Wide Temperature Range  
-55° to +150°C  
Fluid Exposure  
Wide Pressure Changes

#### ZONE 5: WING AND WHEEL WELL

High Vibration  
Extreme Temperature Range  
-55° to +200°C  
Fluid Exposure  
Wide Pressure Changes

#### ZONE 3: NACELLE AND PYLON

Dynamic Vibration Environment  
Extreme Temperature Range  
-65° to +200°  
Firewall  
Fuels and Fluids

### AIRCRAFT ZONES: MACRO ENVIRONMENTS

Significant variability exists between the various macro environments of a modern commercial aircraft (dynamic stimulus, moisture, humidity, thermal extremes, and so on). Environmental stress factors place a demand on the electrical interconnect components that must perform for the expected life of 20 years. Macro environments range from the cabin interior—where the challenge is mainly moisture / humidity—to extreme unpressurized zones such as wing and wheel wells where extreme dynamic stimuli combined with thermal extremes can rapidly degrade the performance and life expectancy of interconnect technologies.





# Qualified Glenair Interconnect Technologies for Aircraft Electrical Wiring Interconnect Systems

Organized by type with zone designators

## ELECTRICAL CONTACTS / SEALING CONTACTS • Suitable for use in Aircraft Zones 1, 2, 3, 4, 5, 6, 7, and 8



Standard and high-density signal

Extended-duty signal (up to 1500 cycles)

High-speed, RF, and El Ochito® contacts

Lightweight sealing plugs and dummy sealing contacts

## ULTRAMINIATURE CIRCULARS • Suitable for use in Aircraft Zones 1, 2, 3, 4, 5, 6, 7, and 8



Series 806 Mil-Aero: small form-factor equivalent for MIL-DTL-38999

Series 806 Mil-Aero glass-sealed hermetics

Series 806 Mil-Aero CODE RED-sealed hermetics

## MIL-AERO CIRCULARS • Suitable for use in Aircraft Zones 1, 2, 3, 4, 5, 6, 7, and 8

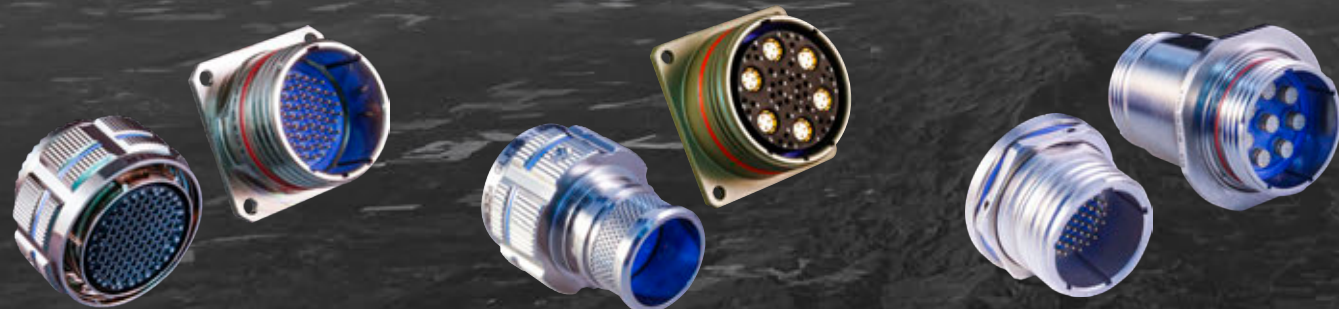

QPL MIL-DTL-38999 Series III  
Suitable for Zones 1 and 2 only

SuperNine® MIL-DTL-38999 Series III +  
Better than QPL™ performance

SuperNine® MIL-DTL-38999 Series III +  
glass- and CODE RED-sealed hermetics

## HIGH-SPEED DATALINK CONNECTORS • see below for zone designators



SuperSeal™ MIL-DTL-38999 RJ45  
Suitable for Zones 1, 2, and 8

SuperSeal™ MIL-DTL-38999 USB 2.0  
Suitable for Zones 1, 2, and 8

GateLink Pro high-speed data uplink  
Suitable for Zone 2

## FIBER OPTICS • Suitable for use in Aircraft Zones 1, 2, 3, 4, 5, 6, 7, and 8



SuperNine® MIL-DTL-38999 Series III type  
tight-tolerance fiber optics

Series 806 Mil-Aero  
high-density fiber optics

Qualified fiber optic termini

## POWER CONNECTORS AND PRESSURE BOUNDARY FEEDTHRU • see below for zone designators



PowerLoad™ power distribution connectors  
Suitable for Zones 1, 2, 3, 4, and 7

PowerLoad™ bulkhead feedthru  
Suitable for Zones 1, 2, 3, 4, and 7

Pressure boundary and firewall feedthrus  
Suitable for Zones 1 – 7

## EMI/RFI BRAIDED SHIELDING AND PROTECTIVE COVERING • Suitable for use in Aircraft Zones 1 – 8

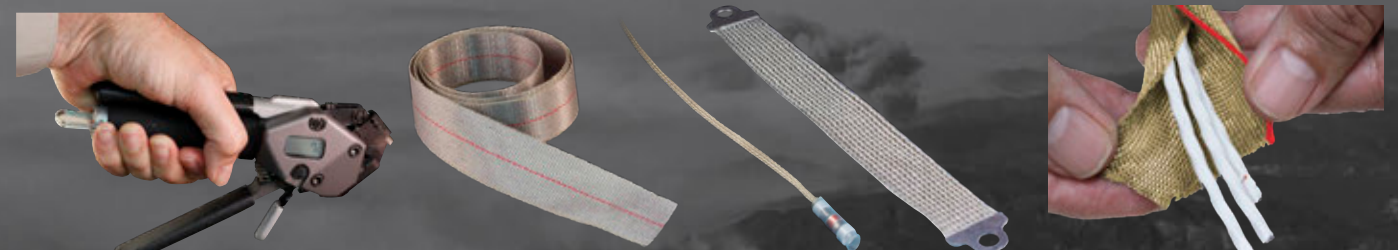

Band-Master ATS® advanced  
shield termination system

ArmorLite microfilament  
EMI/RFI shielding

Lightweight, flexible  
ground straps and HSTs

MasterWrap side-entry  
wraparound shielding

## CONNECTOR BACKSHELLS AND ACCESSORIES • Suitable for use in Aircraft Zones 1 – 8



ProSeal spring-action  
protective covers

Environmental  
protective covers

Swing-Arm FLEX  
composite backsells

Swing-Arm standard and  
wide-mouth composite backsells

## SPECIAL-PURPOSE EWIS TECHNOLOGIES • see below for zone designators



Advanced rectangular aviation  
backsells (ARINC 600 shown)  
Suitable for Zones 1, 2, 5, 6, 7, 8

Receptacle / bulkhead  
connector nut plates  
Suitable for Zones 1 – 8

SpliceSaver time- and labor-  
saving wire splice replacement  
Suitable for Zones 1, 2, 7, and 8

Polymer- and metal-core conduit  
wire protection systems  
Suitable for Zones 5, 6, and 8





**ZONE 1  
Fuselage Mid-Wing**

Glenair standard and signature interconnect technologies

**ZONE 1**

**Fuselage Mid-Wing**

Forward barrel section plus center section and aft-of-wing barrel section (pressurized passenger / crew cabin)



The main passenger cabin, crew and galley areas are housed in the fuselage mid-wing. This pressurized zone is characterized by moderate environmental stress factors such as fluid condensation, humidity, temperatures in the -65° to +95°C range, and moderate dynamic vibration. The electrical wiring interconnect system utilizes mostly conventional interconnect technology, with an emphasis on general weight reduction, reliability, and speed-of-assembly. Production breaks are a significant challenge for the EWIS engineer, with cost control of interconnect interfaces a principal design requirement. The pressurized interface between the mid-wing fuselage and the wings requires careful attention in the specification and use of pressure bulkhead feedthrus.

**Glenair SpliceSaver™**

- Crimp wire termination solution saves time and labor over manual DO150 splicing
- Ideally suited for crown and floor wiring in Zone 1
- Three versions: single-piece, Spirallock®, and bussed
- Features Stinger™ crimp contact technology with integrated retention mechanism
- Small form-factor and lightweight composite
- Supports 1–3 wire terminations

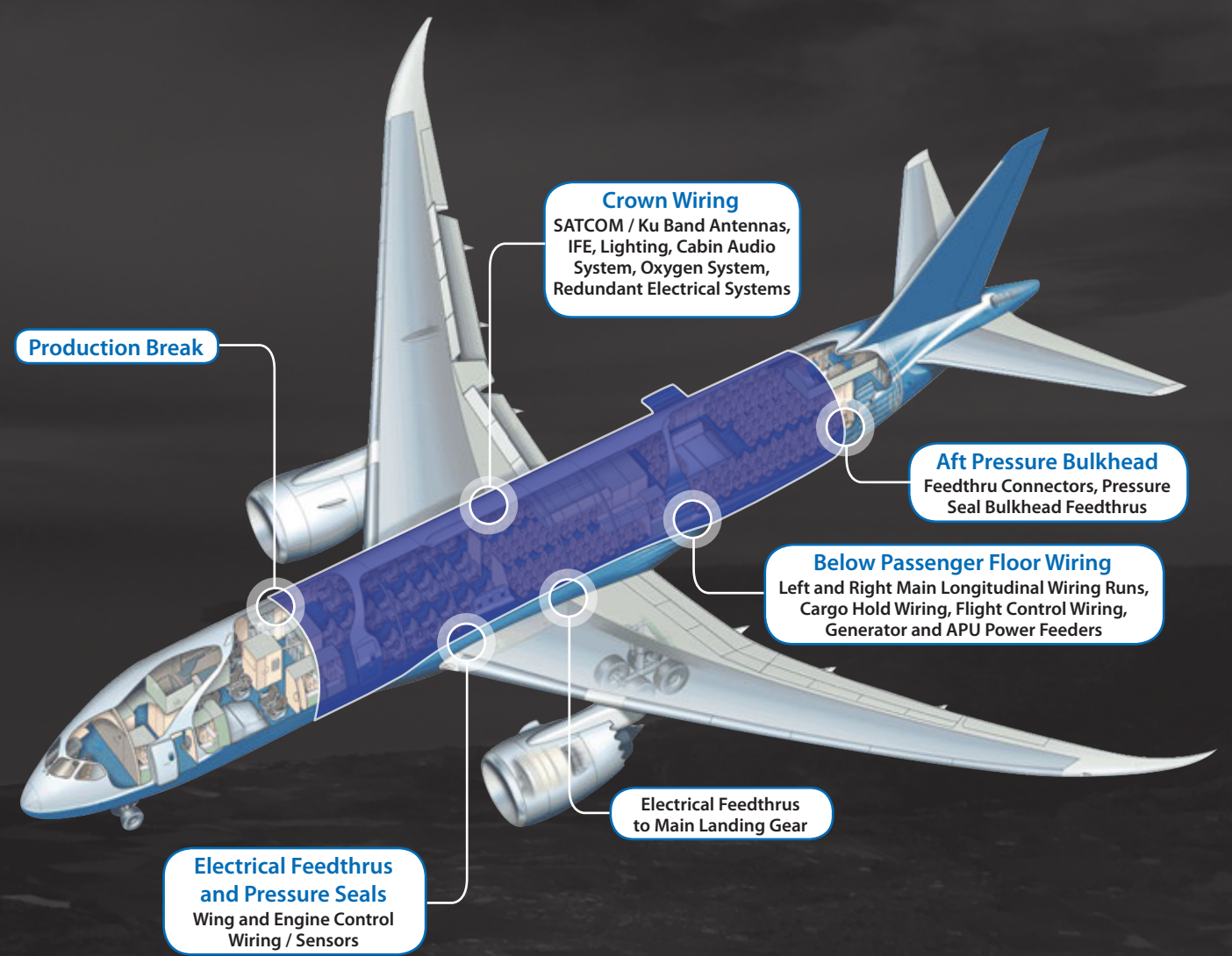

**Qualified Glenair Technologies for Zone 1: Fuselage Mid-Wing**

- SuperNine® MIL-DTL-38999 Series III +
- SuperSeal™ RJ45 and USB 2.0
- MIL-DTL-38999 Series III Fiber Optics
- Series 806 Mil-Aero High-Performance Ultraminiature
- Series 806 Mil-Aero Fiber Optics
- AS39029 signal / high-speed contacts / El Ochito®
- DCSP Dummy Contact Sealing Plugs
- ProSeal™ spring-action protective covers
- Connector protective covers
- Swing-Arm FLEX® composite backshells
- Advanced rectangular aviation backshells
- Series 806 Mil-Aero nut plates
- Band-Master ATS® shield termination system
- ArmorLite™ lightweight microfilament EMI/RFI braid
- ArmorLite™ ground straps
- MasterWrap™ side-entry EMI/RFI shielding
- SpliceSaver™ connectors
- PowerLoad™ connectors and bulkhead feedthrus
- Pressure seal bulkhead fittings
- Hermetic connectors

Zone 1 Application Guidelines	
Environmental Stress Factors	Applicable RTCA/DO-160 Requirements
Vibration	DO-160 Category S and H (Table 8-1)
Shock	DO-160 Category A, Test Procedure 1
Ground Survival Temperature	-65° to 95°C; DO-160 Category A3 (Table 4-1)
Pressure Differential	Sea level to 10kft; DO-160 Category A3 (Table 4-1)
Operating Temperature	-55° to 85°C; DO-160 category A3 (Table 4-1) with Temperature change rate per DO-160 Category A (10 C min per minute)
Moisture	Exposure to humidity and condensation; DO-160 Category B



LABOR- SAVING  
EWIS SPLICE  
CONNECTOR



Crimp wire termination solution saves time and labor over manual D0150 splicing

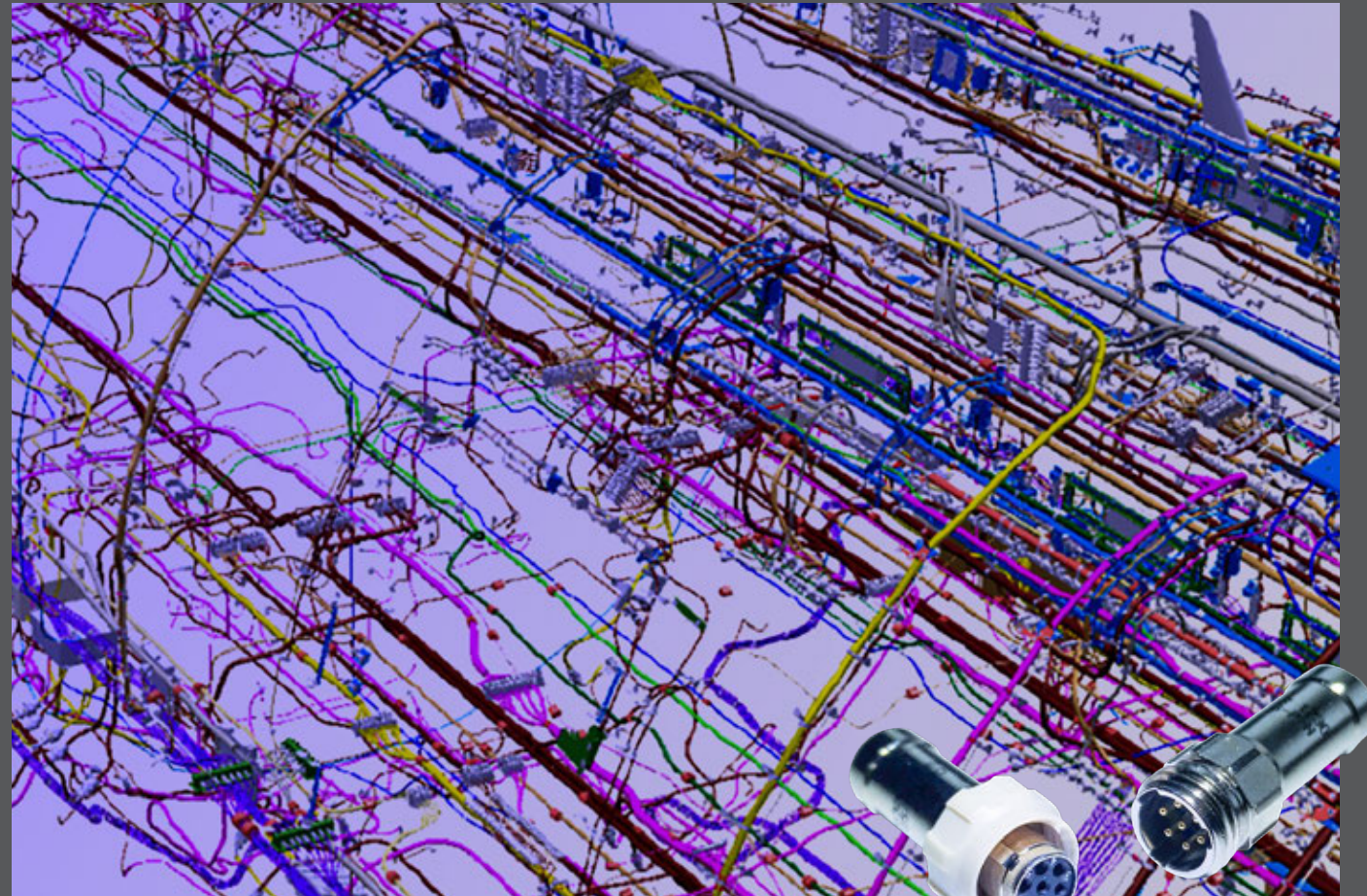

## Glenair SpliceSaver™ reduces manual wire splice and terminal block operations

SpliceSaver™ is an innovative interconnect technology developed by Glenair for use in aircraft wiring operations that rely on heat shrink splicing of aircraft signal, sensor, and data transmission wiring. Single-piece SpliceSaver designs allow remote harness assembly facilities to pre-terminate each line with a crimp-and-poke contact. During aircraft wire harness installation, cabling is routed to interconnection points and the contact-equipped wires are quickly and easily installed into the lightweight single-piece SpliceSaver connector. Two-piece Spirallock® SpliceSaver designs enable the harness facility to terminate wires to the small form-factor, lightweight “connector” for subsequent mating on the aircraft. A special bussed version is also available. All SpliceSaver styles feature integrated banding platforms for the termination of EMI shielding utilizing qualified banding technology—one-piece design features three platforms for termination at both ends and in the center. Compared to legacy terminal blocks and wire splice technology, SpliceSaver offers faster, cleaner, and more reliable routing and termination of discrete wiring.

- Lightweight construction
- Conductive (plated) or non-conductive versions
- Crimp contact technology: front release/rear removal
- Three to nineteen circuits per unit
- Environmentally sealed
- Full-mate indicator
- Replaces labor-intensive terminal blocks and splices

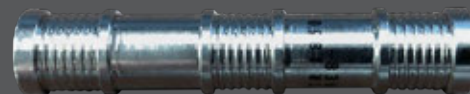

## ZONE 1 FEATURED TECHNOLOGY

SpliceSaver™ Fast and reliable replacement for wire splice and terminal block technologies

GLENAIR  
**QwikConnect**

### SPLICESAVER AVAILABLE CONFIGURATIONS—FEATURES AND SPECIFICATIONS

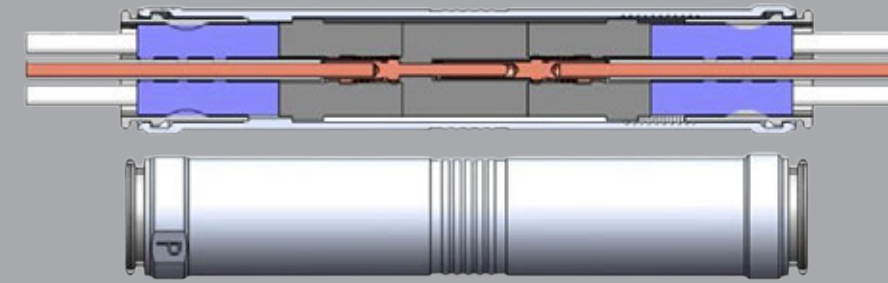

Single-Piece

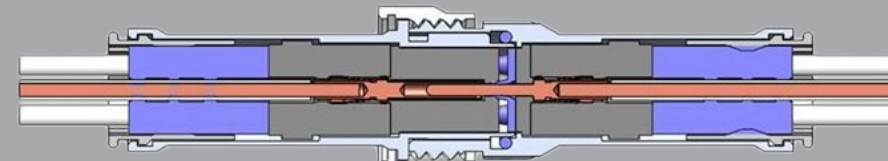

Spirallock® Threaded

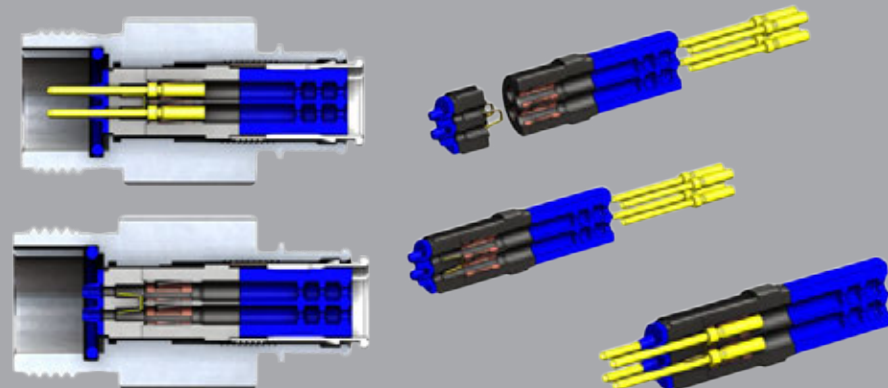

Bussed

- Triple ripple grommet wire seal for sealing at high altitude
- Machined contact utilizes mil-spec crimp tooling
- Contacts are removable allowing corrections to circuits during testing if required

#### SpliceSaver™ Specifications

**Altitude immersion:**  
75,000 ft.

**DWV rating at altitude:**  
>800 V

**Dielectric Withstanding Voltage Ratings:**  
22AWG = 5 amps/contact  
20AWG = 7.5 amps/contact

**Material and finish options**  
(for compatibility with available EMI/RFI braid materials):  
Cadmium-plated aluminum  
Nickel-plated aluminum  
Nickel-plated brass

#### SpliceSaver™ Weight Analysis

**Receptacle connector:**  
1.6 grams including contacts and seals

**Plug connector:**  
1.66 grams including contacts and seals

**Total connector mass:**  
5.66 grams (all contact locations installed)

**Accessories:** Add the variable mass of two or three nano bands trimmed to length of grooves in the split sleeve





ZONE 2

Instrument Panel Console / Equipment Rack

GLENAIR  
**QwikConnect**

Glenair standard and signature interconnect technologies

ZONE 2

# Instrument Panel Console and Equipment Rack Within the forward fuselage

The instrument panel console and equipment rack zone of the aircraft, Zone 2, is housed within the forward section of the fuselage. Zone 2 has the most diverse range of interconnect technologies found in the aircraft, meeting a diverse set of application and performance requirements. This section includes the flight deck with its extensive set of avionic displays, control panels, communications equipment, data uplink and downlink interfaces, antennae, and so on. These equipment sets interface with the avionics and flight management computers located in the lower part of the forward fuselage in the equipment bay. The equipment bay also hosts power panels and power conversion panels located adjacent to the equipment racks. This section of the aircraft may also contain a galley, depending on airline configuration.



### GateLink Pro™

- High-speed data uplink connector for gate-to-aircraft applications
- Ideally suited for Zone 2
- Durable pogo pin contact system rated to tens of thousands of mating cycles
- Sealed receptacle available with ProSeal™ spring-action protective covers
- Rugged overmolded plug cable (turnkey)
- Environmentally sealed breakaway design
- Proven commercial airframe performance

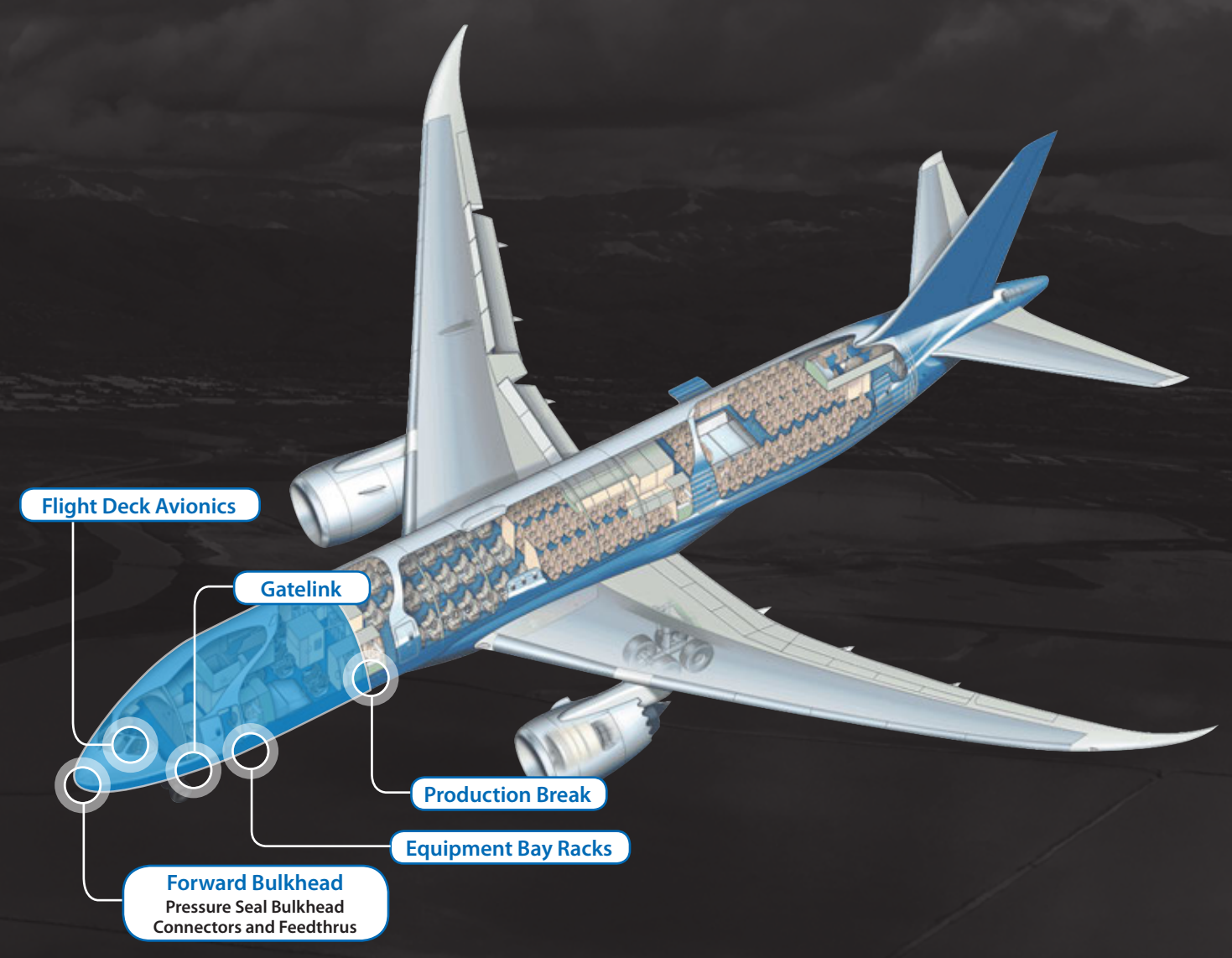

Zone 2 Application Guidelines	
Environmental Stress Factors	Applicable RTCA/DO-160 Requirements
Vibration	DO-160 Category S and H (Table 8-1)
Shock	DO-160 Category A, Test Procedure 1
Ground Survival Temperature	-65° to 95°C; DO-160 Category A3 (Table 4-1)
Pressure Differential	Sea level to 10kft; DO-160 Category A3 (Table 4-1)
Operating Temperature	-55° to 85°C; DO-160 category A3 (Table 4-1) with Temperature change rate per DO-160 Category A (10 C min per minute)
Moisture	Exposure to humidity and condensation; DO-160 Category B

### Qualified Glenair Technologies for Zone 2: Instrument Panel Console and Equipment Rack

- MIL-DTL-38999 Series III QPL
- SuperSeal™ RJ45 and USB 2.0
- MIL-DTL-38999 Series III Fiber Optics
- Series 806 Mil-Aero High-Performance Ultraminiature
- Series 806 Mil-Aero Fiber Optics
- Series 79 ultraminiature crimp rectangulars
- AS39029 electrical contacts
- DCSP Dummy Contact Sealing Plugs
- ProSeal™ spring-action protective covers
- Connector protective covers
- Swing-Arm FLEX® composite backshells
- Advanced rectangular aviation backshells
- Band-Master ATS® shield termination system
- ArmorLite™ lightweight microfilament EMI/RFI braid
- ArmorLite™ ground straps
- MasterWrap™ side-entry EMI/RFI shielding
- SpliceSaver™ connectors
- PowerLoad™ connectors and bulkhead feedthrus
- Pressure seal bulkhead fittings
- Hermetic connectors



HIGH-SPEED  
QUICK-DISCONNECT  
DATA UPLINK

# GateLink Pro™

GateLink Pro™  
High-Speed Data  
Uplink Connector

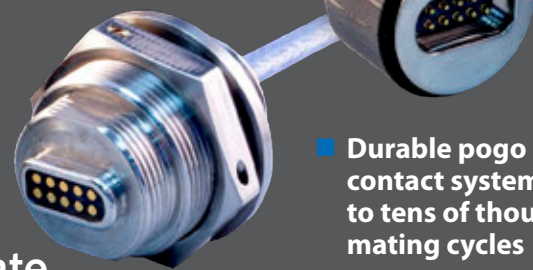

## Environmentally-sealed breakaway design for high-speed data transfer between terminal gate and aircraft

GateLink Pro™ connectors are exactly designed to meet the needs of airport terminal-to-aircraft data uplinks. The IP68 sealed receptacle connector on the aircraft is designed for low profile environmental performance (available ProSeal™ protective cover adds additional environmental protection). Plug connectors are ruggedized for rough handling with pogo pin contacts and retention springs recessed deep into the plug to prevent damage. Designed for fast and reliable high-speed Ethernet data transfer up to 1Gb / second. Turnkey overmolded cable assemblies as well as discrete connectors and environmental shrink boots are available.

- Durable pogo pin contact system rated to tens of thousands mating cycles
- Sealed receptacle available with ProSeal spring-action protective cover
- Straight or right-angle AutoShrink wire protection boots or rugged overmolded plug assemblies for reliable environmental protection

## ZONE 2 FEATURED TECHNOLOGY GateLink Pro™

IP68 sealed high-speed data uplink connector

GLENAIR  
QwikConnect

### GATELINK PRO APPLICATIONS AND SOLUTIONS

Wired datalink interconnect access to the aircraft from the airline terminal gate supports various information domains and data types including aircraft traffic control, airline information services, passenger entertainment, weather, and so on. Airline operating center applications (flight plans, schedules, advisories) are quickly and reliably uploaded to the aircraft during turnarounds at the gate. Mechanical and environmental damage to the datalink interface is a common problem solved by GateLink Pro.

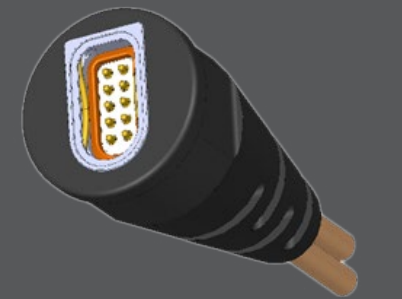

Overmolded environmental plug. CAD drawing shows polarized shape of mating interface as well as internal sealing and retention spring.

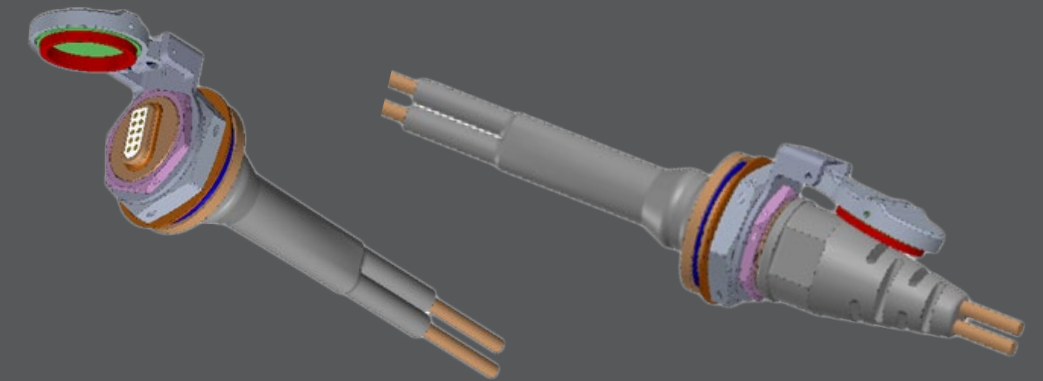

IP68 sealed receptacle. CAD drawing shows integrated ProSeal™ protective cover and AutoShrink™ environmental sealing / strain relief boot.

Mated GateLink Pro™ plug and receptacle. CAD drawing shows shielded twisted pair cabling and overmold cross-section of available turnkey cable assembly

### GATELINK PRO SPECIFICATIONS



Voltage rating	500 VAC
Current rating	5 amps
Contact resistance	20 milliohms maximum
Plug-to-receptacle ground resistance	<5 milliohm
Maximum wire size	#24 AWG
Insulation resistance	5000 megohms min.
Water immersion	MIL-STD-810 Method 512, one meter for one hour
Durability	2000 mating cycles
Corrosion resistance	1000 hours
Sine vibration	EIA-364-28 condition IV, 20g peak
Random vibration	EIA-364-28 condition V letter H, 29g rms
Shock	EIA-364-27 condition D, 300g peak
EMI shielding effectiveness	40 dB minimum to 10 GHz

### GATELINK PRO AVAILABLE ACCESSORIES

LEONARDO'S  
**PROSEAL**  
spring-action protective covers



Anti-vibration and shock spring-action solution •  
Self-aligning environmental seals

**AUTOSHRINK™**

Autoshrink is a high-performance elastomeric material (Glenair Duralectric™ formula polymer GPS67) cold-action shrink boot and jacket solution for commercial aerospace electrical wire interconnect systems

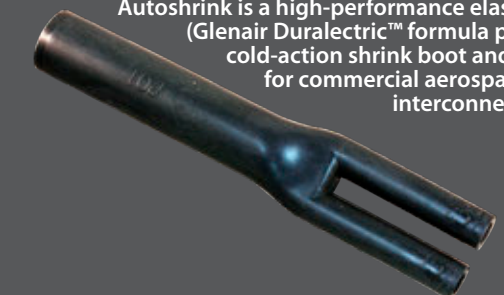





## ZONE 3 Nacelle and Pylon

Glenair standard and signature interconnect technologies

## ZONE 3

# Nacelle and Pylon

Immediate adjacency to engine and gear box plus wing and wheel well

This zone of the aircraft experiences high vibration, heat, frequent maintenance cycles, and susceptibility to chemical contamination. There are critical variable temperature zones within the engine cowling. Typically, the region around the fan is cooler, with temperatures in the range of 85° – 95°C. Aft of the fan, temperatures increase dramatically. Design coordination with the aircraft manufacturer is required for all EWIS technologies routed in and out of the nacelle and via the pylon.



### Firewall and Pressure Boundary Feed-Thrus

- High-grade engineering thermoplastic or machined metal
- Solid and split-shell versions
- Ideally suited for pressure, vapor, and firewall bulkheads throughout the aircraft including Zone 3
- O-ring sealed panel and box mounting interface
- Conductive and non-conductive finish options

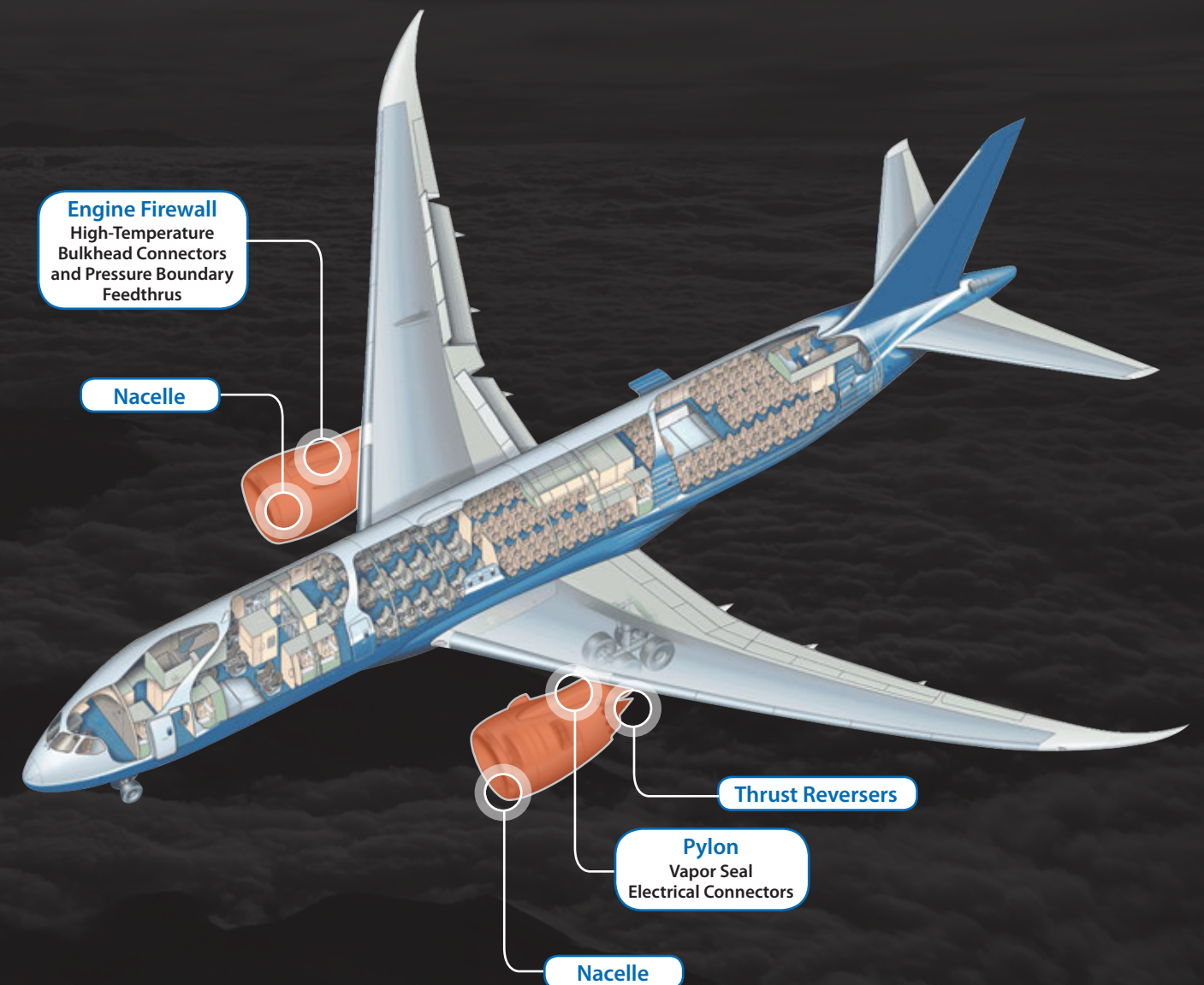

### Qualified Glenair Technologies for Zone 3: Nacelle and Pylon

- SuperNine® MIL-DTL-38999 Series III +
- MIL-DTL-38999 Series III Fiber Optics
- Series 806 Mil-Aero Fiber Optics
- AS39029 electrical contacts
- DCSP Dummy Contact Sealing Plugs
- ProSeal™ spring-action protective covers
- Connector protective covers
- Swing-Arm composite and SS backshells
- Band-Master ATS® shield termination system
- ArmorLite™ lightweight microfilament EMI/RFI braid
- ArmorLite™ ground straps
- PowerLoad™ connectors and bulkhead feedthrus
- Firewall / pressure-seal feed-thrus
- Hermetic connectors

Zone 3 Application Guidelines	
Environmental Stress Factors	Applicable RTCA/DO-160 Requirements
Vibration	DO-160 Category S and H (Table 8-1)
Shock	DO-160 Category D, Test Procedure 1
Ground Survival Temperature	-65° to 200°C; DO-160 Category D3
Pressure Differential	Sea level to 50kft; DO-160 Category D3
Operating Temperature	-55° to 200°C; DO-160 category D3
Moisture	Exposure to humidity and condensation; DO-160 Category B



**FIREWALL AND  
PRESSURE SEAL  
FEED-THRU**

Versatile cable feed-thrus  
for pressure, vapor, and  
firewall applications



**FAA qualified pressure-boundary feed-thrus for high temperature and vapor seal applications including jet engine firewalls**

Glennair is the go-to design partner for innovative solutions to electrical wire interconnect system problems in airframe applications. Our backshell and connector accessory design engineers are responsible for more problem-solving innovation in our industry than every other connector accessory supplier combined. Take our new firewall and pressure boundary feed-thru fittings, for example. Available in both one-piece and split-shell designs, these FAA-qualified cable feed-thrus provide fast, trouble-free installation and life-of-system performance. Solid and split insulators add additional flexibility in installation. All designs supplied for "D" panel cutout profiles with jam nut attachments and O-rings for reliable fitting-to-bulkhead sealing.



- Universal shell size with over 40 insert arrangements
- Full wire size accommodation range up to 1" (25.4 mm)
- Stainless steel (Z1) material and finish for firewall applications
- Lightweight composite material and finish (XB) for pressure and vapor seal applications
- Catalog solutions as well as fast turnaround on made-to-order configurations, typically only two to three weeks

**ZONE 3 FEATURED TECHNOLOGY**

**Firewall / Pressure Seal Feed-Thrus**



Solid and split-shell designs for high-temperature and vapor seal applications

**PRESSURE BOUNDARY, FIREWALL, AND SPLIT-SHELL FEED-THRUS**



Pressure boundary composite feed-thru

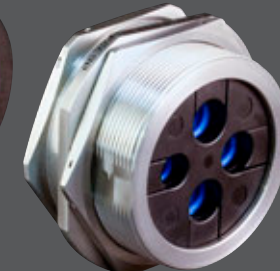

Firewall pressure boundary feed-thru

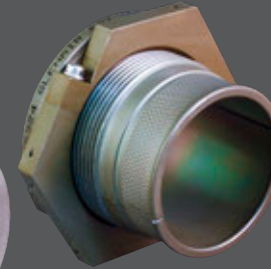

EMI/RFI split-shell metal feed-thru

- High-grade engineering thermoplastic or machined metal
- Wide range of pressure-boundary feed-thru layouts with accommodation for 1 – 6 cables
- Split-shell jam nut versions with EMI/RFI shield termination porch
- O-ring sealed panel and box mounting interface

**INSERT ARRANGEMENTS: CONSULT FACTORY FOR BEST AVAILABILITY ON TOOLED DESIGNS**

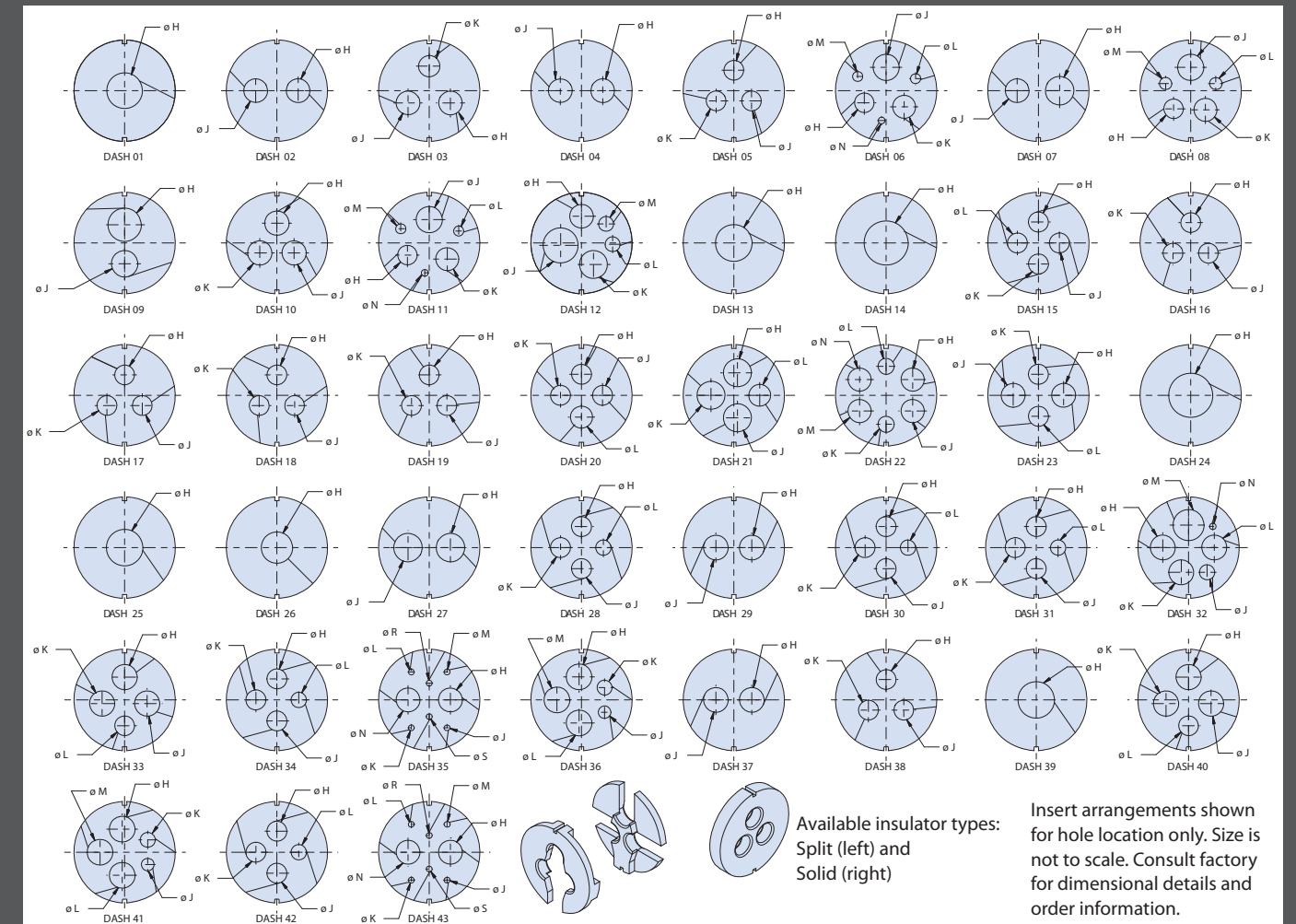



Find the missing number

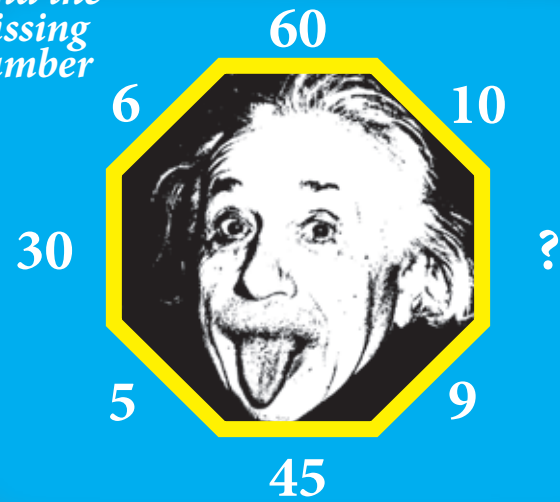

*This five-letter word becomes shorter when you add two letters to it.  
What is the word?*

what's the largest three-digit number you can make

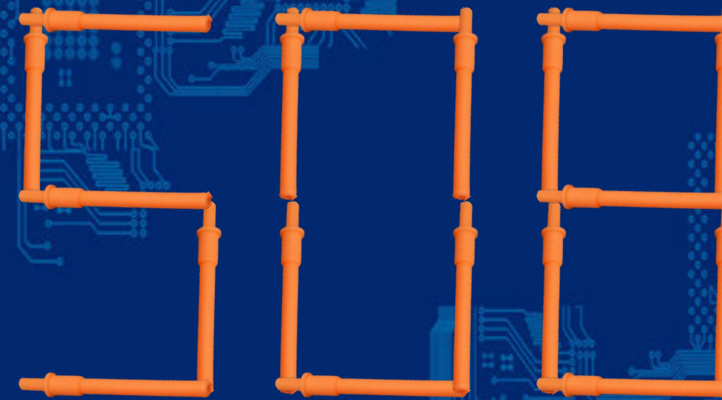

by moving **ONLY TWO** dummy contact sealing plugs?

If...

$123 = 18$

$233 = 24$

$132 = 12$

$532 = 20$

then  $142 = ?$

 +  = 5

 +  = 8

 +  = 7

what are the number values for each shape?

Find the mistake...

BBBB DDDD FFFF

HHHH JJJJ LLLL

NNNN PPPP RRRR

TTTT UUUU

XXXX ZZZZ



How Many Animals Do You See?

Which tank will fill up first?

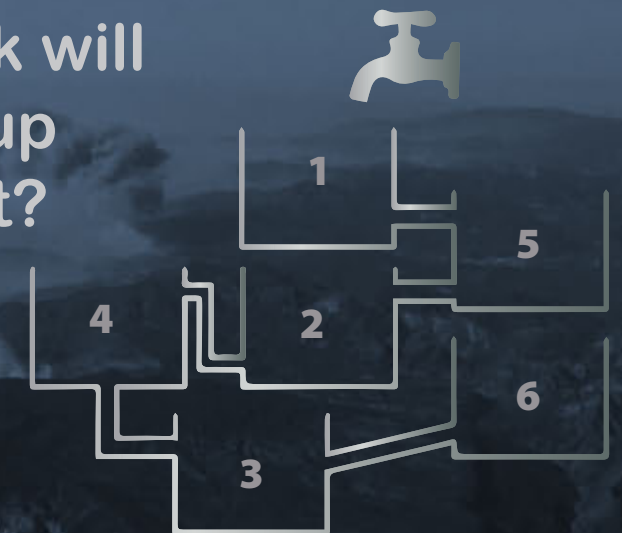

**WHAT ARE THE NUMBERS OF THE PARKING SPACES WITH AIRPLANES IN THEM?**



Which of the numbers are reversed?



One of the spirals is made from one continuous rope, joined at the ends.  
The other is made from two separate pieces.  
Which is which?

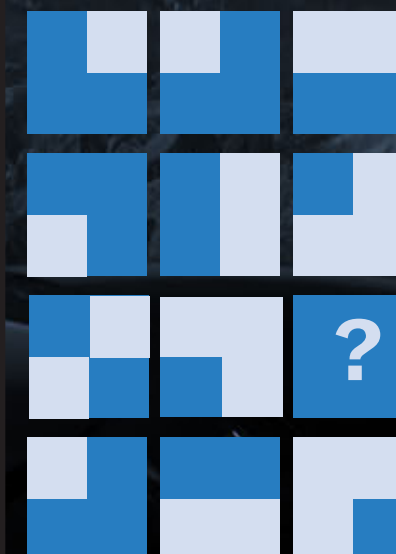

Solve the puzzle.  
A, B, C, or D?

A B C D



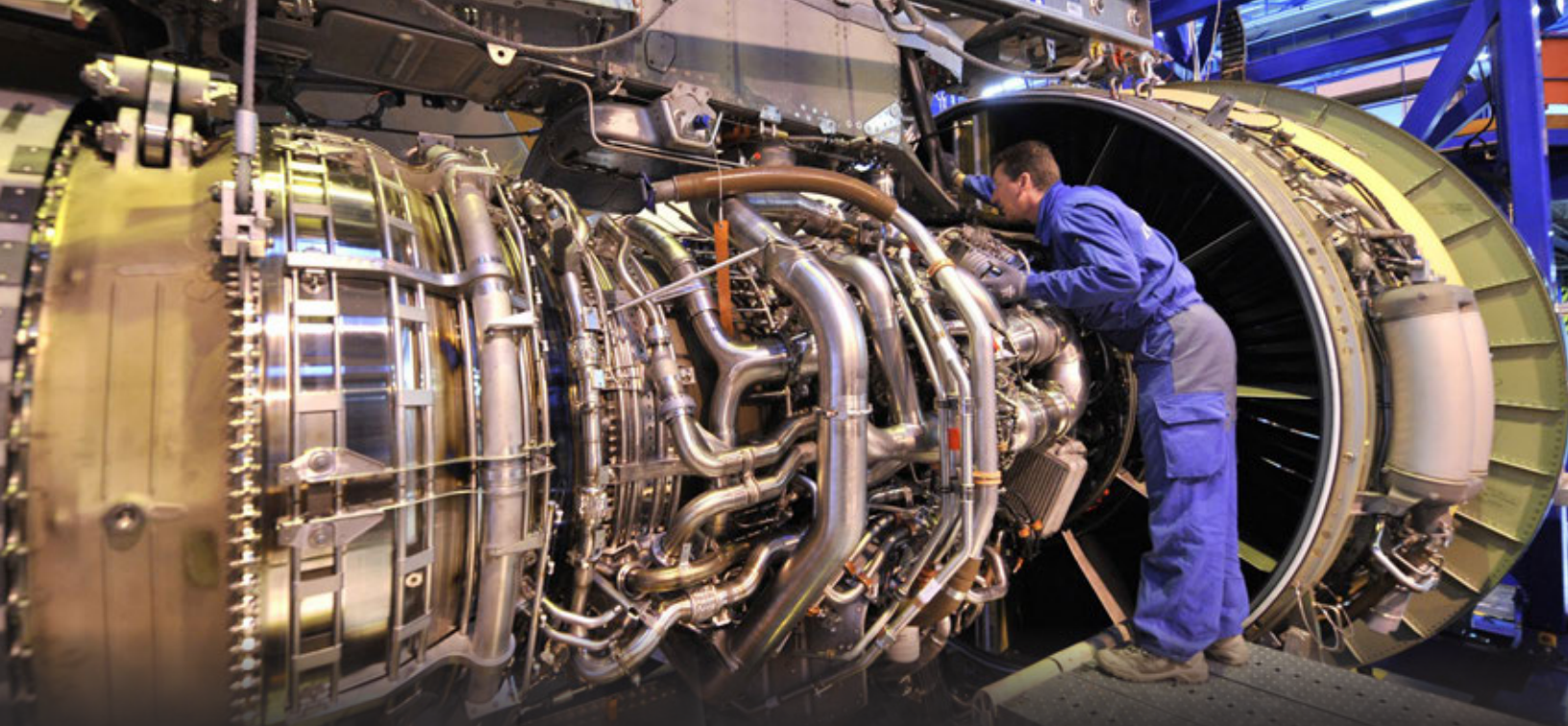

# ZONE 4 Engine and Gear Box

Adjacent to and interconnected with aircraft via engine pylon and the wing/body fairing



EWIS components exposed to high heat can experience accelerated degradation, insulation dryness, and cracking. Direct contact with a high-heat source can quickly damage insulation. Even lower levels of engine and gearbox heat can degrade the EWIS over time. Standard-construction cable harnesses used for interconnection of FADEC equipment or in areas of Zone 5 not in direct contact with the engine may incorporate material types capable of withstanding operating temperatures up to 200°C. Aircraft manufacturers prefer stainless steel connectors and accessories, and cabling shielded with temperature-resistant metallic braid. EWIS cabling transitioning from the engine and gearbox into the adjacent nacelle and pylon zone require pressure and temperature boundary sealing.

Zone 4 Application Guidelines	
Environmental Stress Factors	Applicable RTCA/DO-160 Requirements
Vibration	DO-160 Category S and H (Table 8-1)
Shock	DO-160 Category D, Test Procedure 1
Ground Survival Temperature	-65° to 200°C; DO-160 Category D3
Pressure Differential	Sea level to 50kft; DO-160 Category D3
Operating Temperature	-55° to 200°C; DO-160 category D3
Moisture	Exposure to humidity and condensation; DO-160 Category B

### PowerLoad™ Connectors

- High-vibe, high-temp, high-density power connector series
- Ideally suited for backup generators in Zone 4 as well as power transmission throughout the aircraft
- Low-resistance contact delivers lower temperature rise under load
- Removable wire sealing grommet and wire separator for easy rear release of contacts and improved sealing of tape-wrapped wire

## ZONE 4 Engine and Gear Box

Glenair standard and signature interconnect technologies

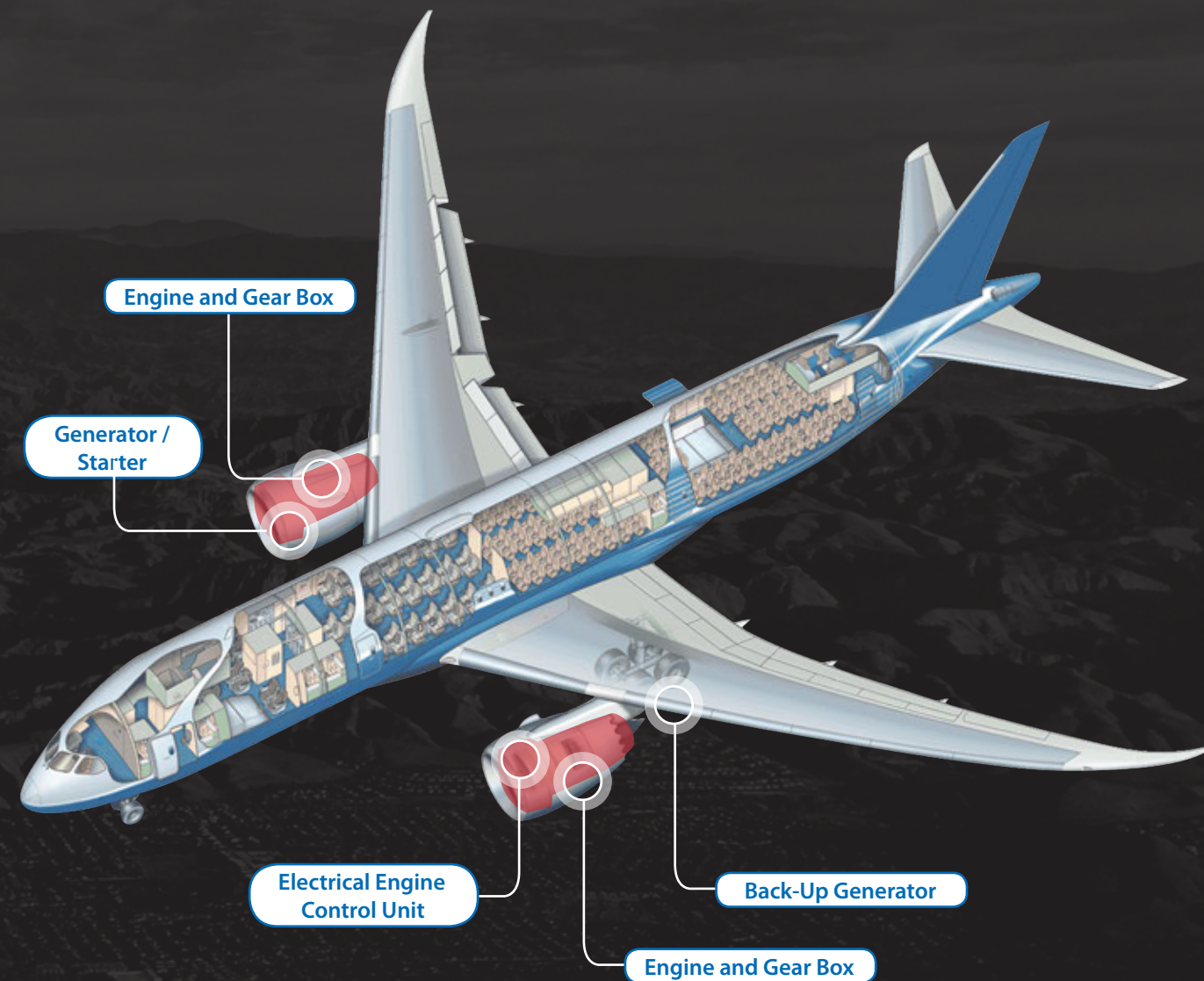

**Qualified Glenair Technologies for Zone 4: Engine and Gear Box**

- SuperNine® MIL-DTL-38999 Series III +
- SuperNine® MIL-DTL-38999 Series III + Fiber Optics
- Series 806 Mil-Aero ultraminiature
- AS39029 electrical contacts
- DCSP Dummy Contact Sealing Plugs
- ProSeal™ spring-action protective covers
- Connector protective covers
- Swing-Arm composite and SS backshells
- Band-Master ATS® shield termination system
- ArmorLite™ lightweight microfilament EMI/RFI braid
- ArmorLite™ ground straps
- PowerLoad™ connectors and bulkhead feedthrus
- Pressure seal bulkhead fittings
- Hermetic connectors
- Indirect lightning strike HST Sleeves
- AutoShrink™ cold-action shrink tubing and boots





**ZONE 5**  
**Wing and Wheel Well**

Glenair standard and signature interconnect technologies

**ZONE 5**

**Wing and Wheel Well**

An unpressurized, harsh environmental zone



Wing leading and trailing edges are harsh environments for EWIS installations. EWIS wire harnesses in this zone are exposed on some aircraft models whenever the flaps or slats are extended. Other potential sources of mechanical damage include slat torque shafts and bleed air ducts.

Wheel wells are also subject to severe external environmental stress factors including impact damage from rocks, ice, and mud, as well as from vibration and chemical contamination. Adequate protection of EWIS cabling in these areas includes shielding, jacketing, and in some applications, enclosure in metal-core or polymer-core conduit.

**Series 806 Mil-Aero**

- **Series 806 Mil-Aero: Advanced-performance ultraminiature circular connector**
- **Ideally suited for all unpressurized aircraft zones including Zone 5**
- **One-to-one equivalent performance to MIL-DTL-38999 Series III, including high-altitude immersion and DWV**
- **Outstanding anti-decoupling performance, even in small shell sizes**
- **Significant size and weight savings compared to MIL-DTL-38999 Series III**

Zone 5 Application Guidelines	
Environmental Stress Factors	Applicable RTCA/DO-160 Requirements
Vibration	DO-160 Category S and H (Table 8-1)
Shock	DO-160 Category D, Test Procedure 1
Ground Survival Temperature	-65° to 200°C; DO-160 Category D3
Pressure Differential	Sea level to 50kft; DO-160 Category D3
Operating Temperature	-55° to 200°C; DO-160 category D3
Moisture	Exposure to humidity and condensation; DO-160 Category B

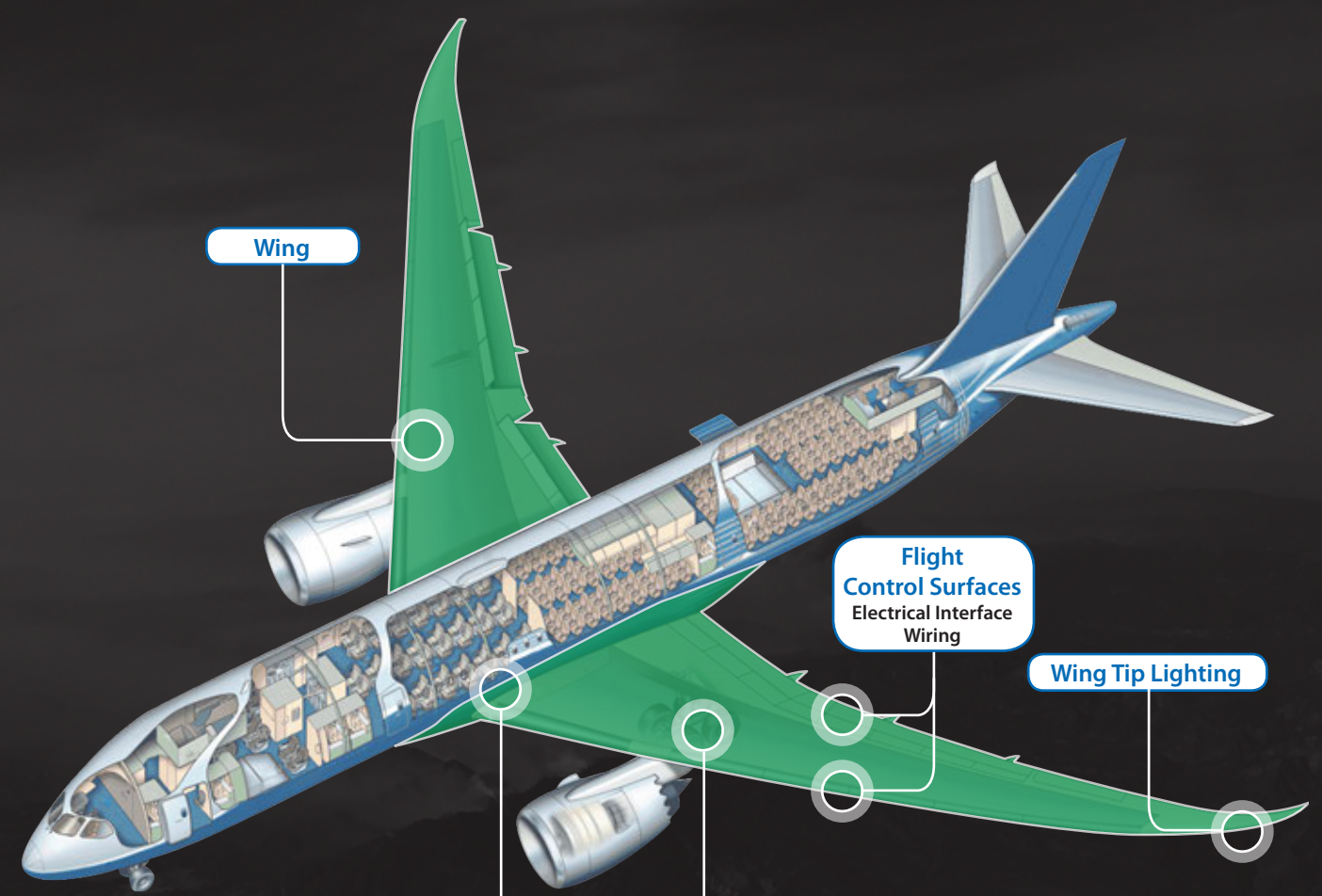

**Qualified Glenair Technologies for Zone 5: Wing and Wheel Well**

- SuperNine® MIL-DTL-38999 Series III +
- SuperNine® MIL-DTL-38999 Series III + Fiber Optics
- Series 806 Mil-Aero High-Performance Ultraminiature
- AS39029 electrical contacts
- DCSP Dummy Contact Sealing Plugs
- ProSeal™ spring-action protective covers
- Swing-Arm FLEX® composite backshells
- Advanced rectangular aviation backshells
- Band-Master ATS® shield termination system
- ArmorLite™ lightweight microfilament EMI/RFI braid
- ArmorLite™ ground straps
- Pressure seal bulkhead fittings
- Hermetic connectors
- Indirect lightning strike HST Sleeves
- Polymer and Metal-Core Conduit





Series 806 offers significant size and weight savings while meeting key performance benchmarks for a broad range of applications such as commercial and military aerospace, robotics, transportation, and more. Designed for general use in harsh vibration, shock, and environmental settings—as well as high-altitude, unpressurized aircraft zones with aggressive voltage ratings and altitude immersion standards—the Series 806 Mil-Aero features numerous design innovations including durable mechanical insert retention, radial seals and triple-ripple grommet seals. Its reduced thread pitch and re-engineered ratchet prevent decoupling problems, particularly in small shell sizes, solving one of the major problems of shell size 9 and 11 MIL-DTL-38999 Series III connectors.

**SAVE SIZE AND WEIGHT WITH SERIES 806 CONNECTORS**



- Next-generation small form factor aerospace-grade circular connector
- Designed for harsh application zones including aircraft wings
- Upgraded environmental, electrical and mechanical performance
- Integrated anti-decoupling technology
- Higher density 20HD and 22HD contact arrangements
- Hermetic, vapor seal, and EMI/RFI filter versions
- +200°C temperature rating

**SERIES 806 MIL-AERO: FEATURES / SPECIFICATIONS**

- High-density #20HD and #22HD arrangements for reduced size and weight
- Supported wire sizes:  
#20HD contacts 20–24 AWG  
#22HD contacts 22–28AWG
- Dielectric withstanding voltage  
#20HD layouts: 1800 Vac  
#22HD layouts: 1300 Vac
- Reduced pitch triple-start modified anti-decoupling stub ACME mating threads
- +200°C operating temperature
- “Triple ripple” wire sealing grommet (75,000 ft. rated)
- Snap in, rear release crimp contacts
- Metal contact retention clips
- Integral Nano-Band shield termination platform
- EMI shielding effectiveness per D38999M para. 4.5.28 (65 dB min. leakage attenuation @ 10GHz)
- 10,000 amp indirect lightning strike
- MIL-S-901 Grade A high impact shock

**AVAILABLE LIGHTWEIGHT ALUMINUM “CODE RED” HERMETICS**

CODE RED is a lightweight encapsulant sealing and application process with 50% package-weight savings compared to glass-to-metal seal Kovar/stainless steel solutions. Non-outgassing CODE RED (IAW NASA/ESA) provides durable hermetic and vapor sealing with better than 1X10<sup>-7</sup> leak rate performance. Gold-plated copper contacts deliver outstanding low-resistance current carrying capacity.

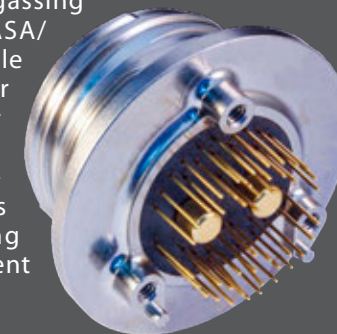

**SERIES 806 MIL-AERO PLUG**

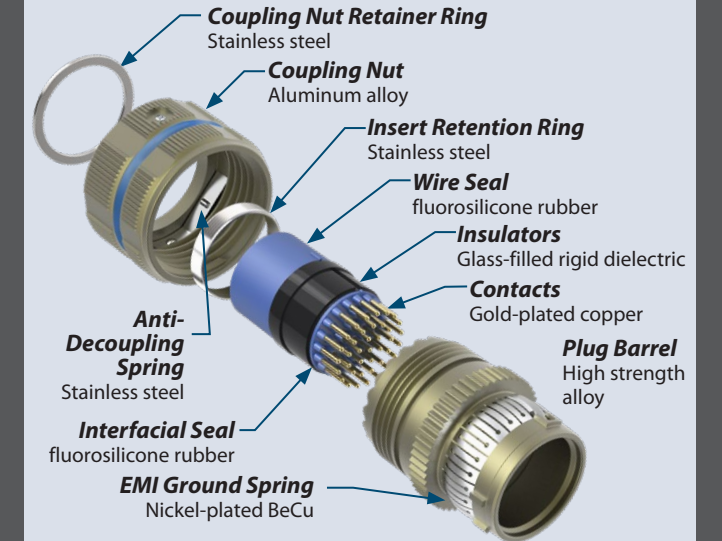

**SERIES 806 MIL-AERO RECEPTACLE**

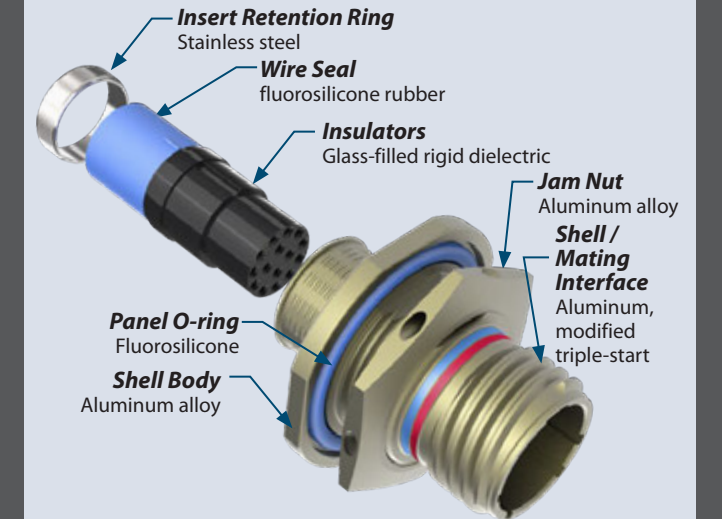

**SMALLER AND LIGHTER WITH EQUAL D38999 PERFORMANCE?**

<p><b>High-Density Layouts</b> Twice as many contacts in a smaller package</p>	<p><b>“Top Hat” Insulator</b> High voltage rating, foolproof alignment</p>	<p><b>Triple Ripple Wire Seal</b> Reliable 75,000 ft. altitude immersion</p>
--	--	--





## ZONE 6 Landing Gear

An unpressurized, harsh environment zone



Commercial airplanes use a nose landing gear and two main landing gears. The nose gear has the steering function, and typically a junction box located midway down the landing gear itself. The main landing gear has an extensive amount of wiring that interfaces with wheel speed sensors, antilock braking equipment, and electric brake systems. The area is exposed to severe external environmental conditions in addition to vibration and chemical contamination. EWIS harnesses interconnecting the landing gear are hardened against impact from rocks, ice, and mud, and may be housed within special metal-core or polymer core conduit.

Zone 6 Application Guidelines	
Environmental Stress Factors	Applicable RTCA/DO-160 Requirements
Vibration	DO-160 Category S and H (Table 8-1)
Shock	DO-160 Category D, Test Procedure 1*
Ground Survival Temperature	-65° to 150°C; DO-160 Category D3
Pressure Differential	Sea level to 50kft; DO-160 Category D3
Operating Temperature	-55° to 150°C; DO-160 category D3
Moisture	Exposure to humidity and condensation; driving rain, de-icer, hydraulic fluids, fuel; EIA-364-10 with the fluids defined in DO-160 Table 11-1

\*note: landing gear environment must be coordinated with airplane manufacturer for specific dynamic environment definition

### Turnkey Wire Protection Assemblies for Wheel Sensor and Braking Systems

- FAA qualified flexible polymer and metal-core conduit materials
- Ideally suited for rugged aircraft zones including Zone 2
- Impact-resistant and immune to chemical contamination
- Integrated overbraiding for added strength and EMI/RFI immunity

## ZONE 6 Landing Gear

Glenair standard and signature interconnect technologies



**Nose Landing Gear**  
Electrical Feedthrus and Pressure Seals

**Main Landing Gear**  
Electric Brakes, Wheel Speed Sensors / Antilock  
Wired metal and polymer-core conduit assemblies

### Qualified Glenair Technologies for Zone 6: Landing Gear

- SuperNine® MIL-DTL-38999 Series III +
- SuperNine® MIL-DTL-38999 Series III + Fiber Optics
- AS39029 electrical contacts
- DCSP Dummy Contact Sealing Plugs
- ProSeal™ spring-action protective covers
- Swing-Arm composite and SS backshells
- Advanced rectangular aviation backshells
- Band-Master ATS® shield termination system
- ArmorLite™ lightweight microfilament EMI/RFI braid
- ArmorLite™ ground straps
- Pressure seal bulkhead fittings
- Hermetic connectors
- Metal- and Polymer-Core Conduit assemblies
- Indirect lightning strike HST Sleeves



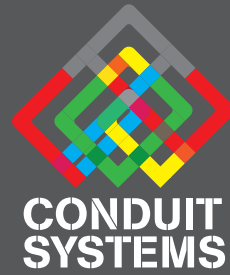

Conduit components and wired assemblies with innovative polymer and metal-core wire protection materials

ZONE 6 FEATURED TECHNOLOGY  
**Conduit Wire Protection Systems**

Flexible, impact resistant alternatives to lighter-duty jacketed cable assemblies



Ultra-flexible polymer-core point-to-point fiber optic conduit assembly

**COMPLEX, MULTIBRANCH ASSEMBLIES WITH INNOVATIVE LIGHTWEIGHT POLYMER-CORE WIRE PROTECTION CONDUITS**



Lightweight, halogen-free PEEK wire conduit assembly

Turnkey integrated box assembly and wired polymer-core interconnect system

PEEK, PFA, ETFE, Siltem polymer core and Glenair signature high-temperature polymer core conduit solutions and user-installable fittings

All of the metal-core conduit and polymer-core convoluted tubing systems we fabricate at Glenair may be wired and assembled at our factory with tamper-proof crimp ring or solder terminations according to customer requirements. Reduced size and weight factory terminated conduit assemblies offer the utmost in environmental ruggedness, reliability and durability. Certified factory assemblers and calibrated tooling guarantee reliable long-term performance. Glenair's expertise in wired conduit systems extends from simple point-to-point jumpers to complex multibranch assemblies as well as turnkey integrated systems and LRUs with flexible conduit interconnect cabling.

**TURNKEY FACTORY-TERMINATED CONDUIT ASSEMBLIES**

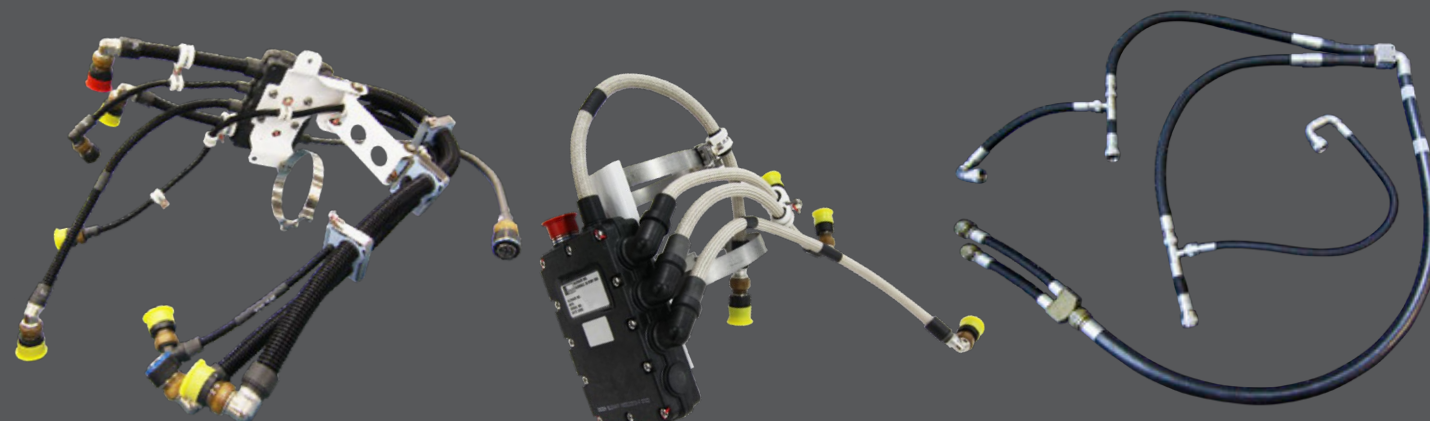

Complex multibranch aircraft electrical wire conduit assembly with high-temperature polymer-core conduit

Lightweight multibranch wire protection conduit assembly with high-temperature polymer-core convoluted tubing

Crush-resistant commercial aerospace metal-core conduit assembly

**COMPLEX, MULTIBRANCH ASSEMBLIES WITH HEAVY-DUTY METAL-CORE CONDUIT AND OVERBRAIDING WIRE PROTECTION MATERIALS**

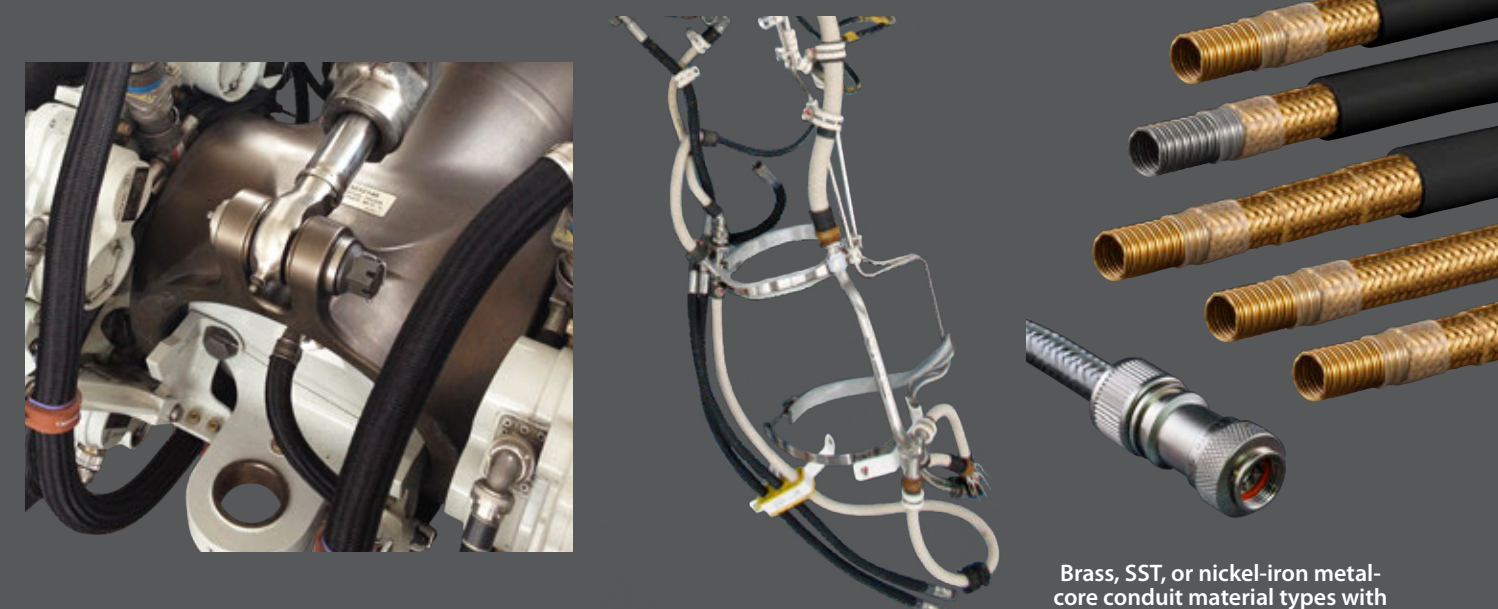

Turnkey wheel well impact-resistant metal-core conduit assembly

Metal-core conduit wire protection aircraft brake assembly

Brass, SST, or nickel-iron metal-core conduit material types with innovative microfilament and drawn filament braiding. Factory terminated or for use with user-installable fittings.





**ZONE 7**  
**Empennage and Vertical Stabilizer Tip**  
 Glenair standard and signature interconnect technologies

**ZONE 7**  
**Empennage and Vertical Stabilizer Tip**  
 An unpressurized harsh environment zone



The empennage, also known as the tail or tail assembly, is a structure at the rear of an aircraft that houses the horizontal and vertical stabilizers, which provide yaw and pitch stability to the aircraft during flight. EWIS cabling interconnecting flight controls, transitions via the aft pressure bulkhead, which protects the cabin interior volume. An Auxiliary Power Unit (APU) and firewall is also located within the tail assembly and is serviced with a broad range of both power as well as signal cabling.

Zone 7 Application Guidelines	
Environmental Stress Factors	Applicable RTCA/DO-160 Requirements
Vibration	DO-160 Category S and H (Table 8-1)
Shock	DO-160 Category A, Test Procedure 1
Ground Survival Temperature	-65° to 200°C; DO-160 Category D3 APU zone (Table 4-1); Category D2
Pressure Differential	Sea level to 50kft; DO-160 Category D2 (Table 4-1)
Operating Temperature	-55° to 200°C; DO-160 category D3 (Table 4-1)
Moisture	Exposure to humidity and condensation; DO-160 Category B

- Swing-Arm® and Swing-Arm Flex**
- Lightweight composite or stainless steel strain relief and EMI shield termination backshell
  - Ideally suited for use throughout the aircraft including Zone 7
  - Versatile 3-in-1 cable routing solution
  - Shield termination options for overall as well as individual wire shielding
  - Innovative drop-in follower designs

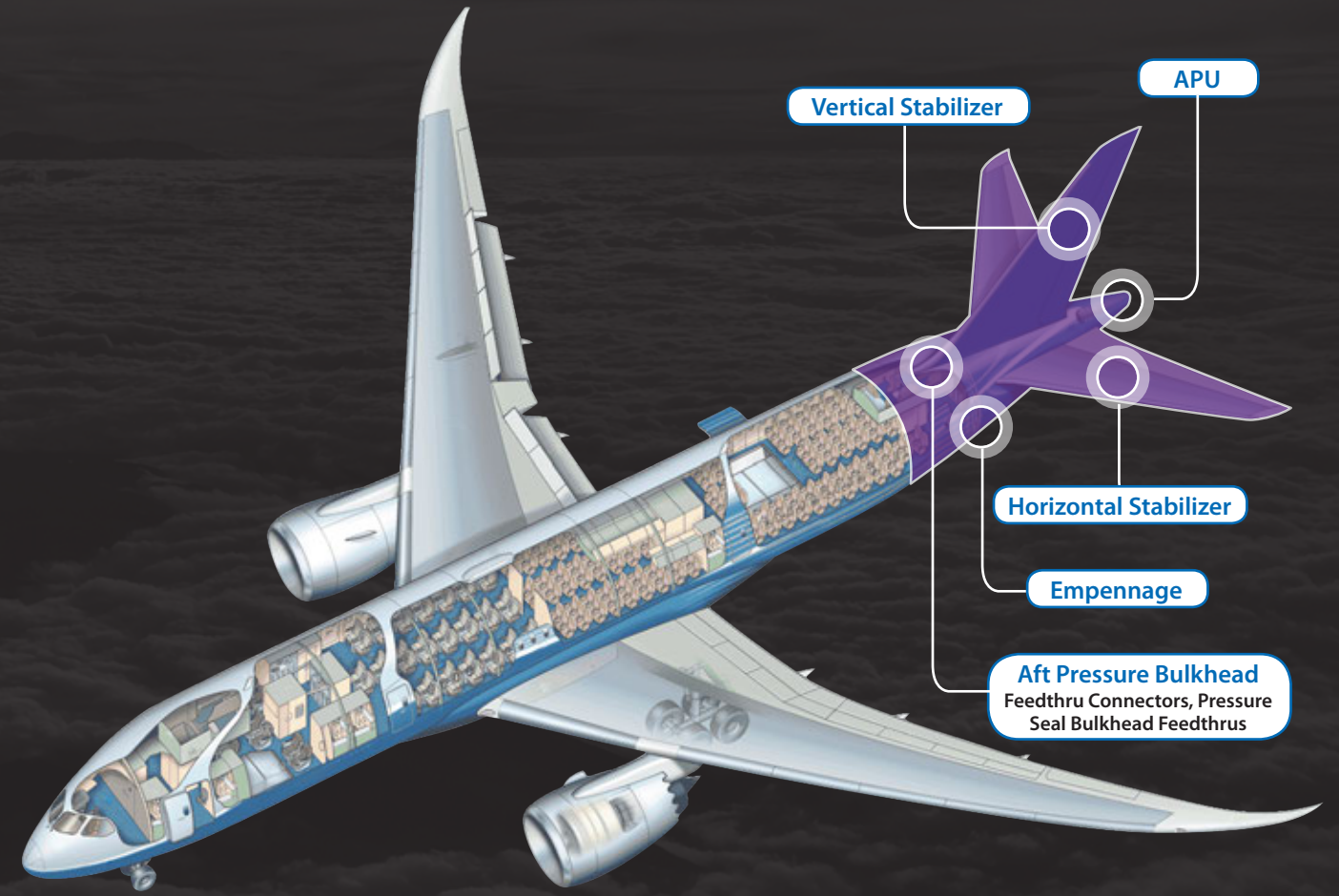

- Qualified Glenair Technologies for Zone 7: Empennage and Vertical Stabilizer Tip**
- SuperNine® MIL-DTL-38999 Series III +
  - SuperNine® MIL-DTL-38999 Series III + Fiber Optics
  - Series 806 Mil-Aero High-Performance Ultraminiature
  - AS39029 electrical contacts
  - DCSP Dummy Contact Sealing Plugs
  - ProSeal™ spring-action protective covers
  - Swing-Arm composite and SS backshells
  - Advanced rectangular aviation backshells
  - Series 806 Mil-Aero nut plates
  - Band-Master ATS® shield termination system
  - ArmorLite™ lightweight microfilament EMI/RFI braid
  - ArmorLite™ ground straps
  - MasterWrap™ side-entry EMI/RFI shielding
  - PowerLoad™ connectors and bulkhead feedthrus
  - Pressure seal bulkhead fittings
  - Hermetic connectors
  - SpliceSaver™ connectors
  - Indirect lightning strike HST Sleeves



WEIGHT SAVING  
EMI/RFI  
STRAIN RELIEF

# SWING ARM®

3-in-1 lightweight composite or stainless steel backshell with optional drop-in braid termination follower

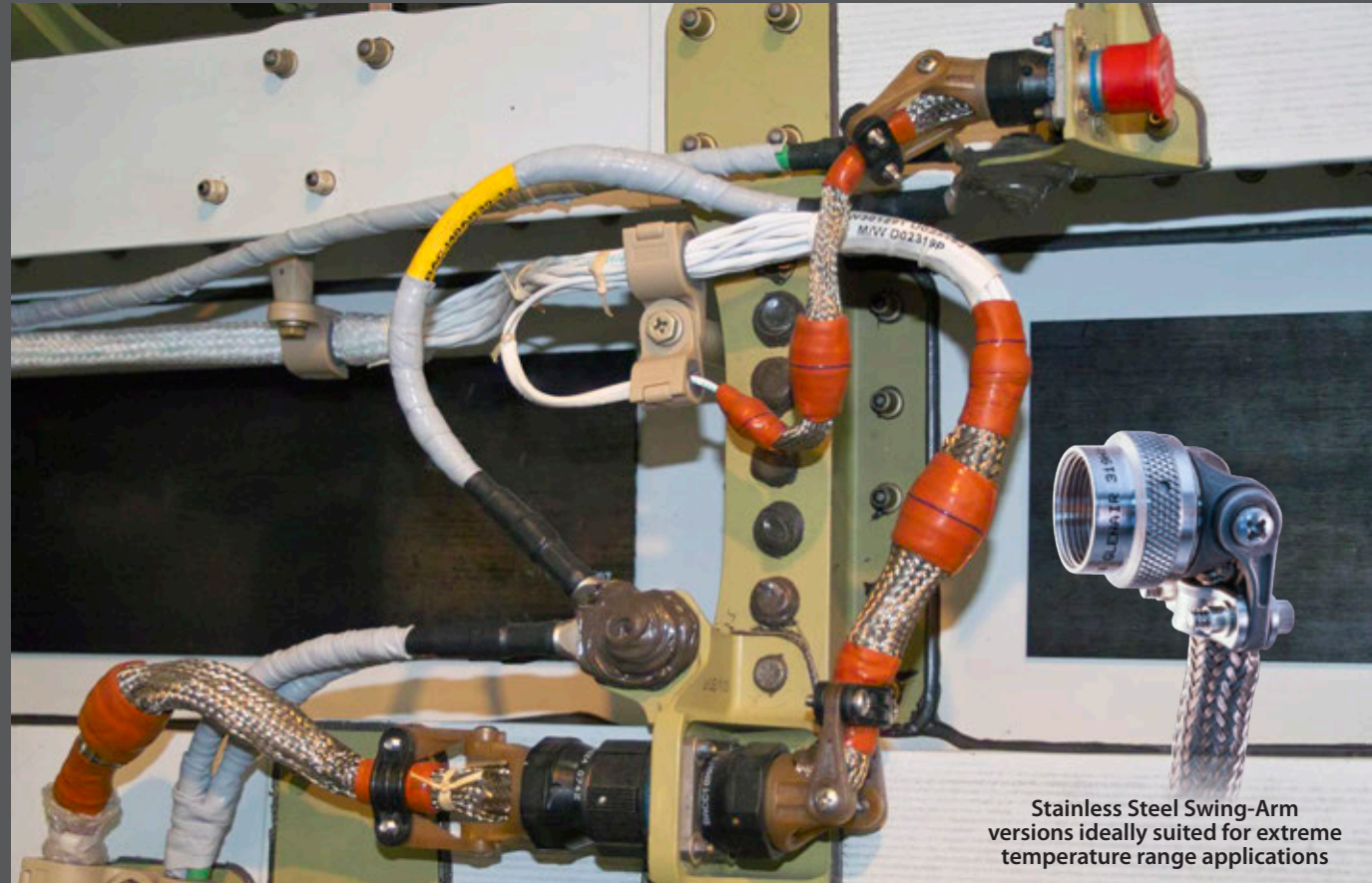

Stainless Steel Swing-Arm versions ideally suited for extreme temperature range applications

Glenair's composite Swing-Arm® strain relief backshell is a lightweight and corrosion-free cable clamp with cable shield termination options for a wide range of EWIS applications. This innovative backshell has become the standard shield termination device for weight reduction in military and commercial airframe applications. Made from temperature-tolerant composite thermoplastic, rugged Swing-Arm® backshells offer easy installation, long-term performance, and outstanding weight and SKU reduction. Performance tested to stringent AS85049 mechanical and electrical standards and available for all commonly-specified mil-standard and commercial cylindrical connectors including MIL-DTL-38999 and Glenair Series 806 Mil-Aero connectors.



SWING ARM®  
COMPOSITE THREE-IN-ONE BACKSHELL  
**FLEX**

User-configurable straight, 45°, and 90° cable routing

## Introducing Swing-Arm FLEX®, Glenair Next-Generation Composite Swing-Arm® Strain Relief

- Significant weight reduction: no saddle bars or hardware
- Rapid assembly: cable self-centers on bundle, little or no wrapping tape required
- Braid sock and drop-in band termination follower versions for EMI/RFI applications
- Internal conductive ground path

## ZONE 7 FEATURED TECHNOLOGY

Swing-Arm 3-in-1 lightweight composite or stainless steel strain-relief and EMI/RFI shield termination backshell

GLENAIR  
**QwikConnect**

### THREE STYLES OF SWING-ARM STRAIN RELIEF CLAMPS

- Style A - standard mouth, rigid saddle bars
- Style B - wide mouth (for larger cable diameters), rigid saddle bars
- Style C Swing-Arm FLEX - no saddle bars, self-centering round cable strain relief

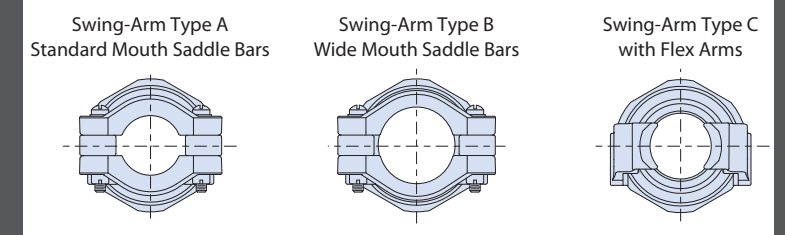

### SWING-ARM VERSATILITY: FROM SIMPLE CABLE STRAIN RELIEF TO EMI/RFI SHIELD TERMINATION



Fast and reliable termination of individual wire and overall EMI cable shielding with industry-standard Band-Master ATS® tools and straps. New slim profile bands eliminate sharp strap cutoff for improved safety.

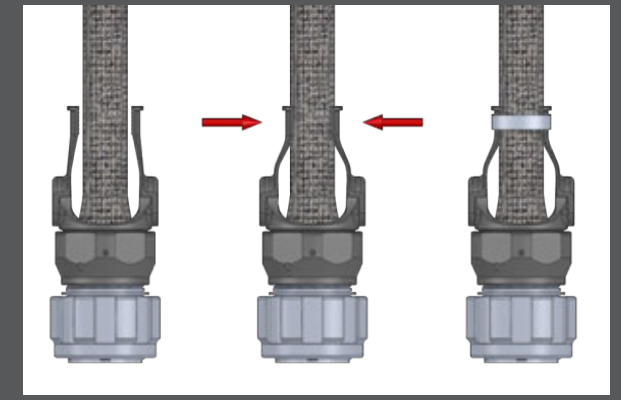

### DROP-IN FOLLOWER FOR DIRECT TERMINATION OF OVERALL OR INDIVIDUAL WIRE SHIELDING



Two drop-in-follower designs, solid and slotted are available for all Swing-Arm styles (A, B, and C).

### SWING-ARM AND SWING-ARM FLEX WITH OPTIONAL INTEGRATED SHIELD SOCK



For fast and reliable EMI/RFI shield termination of individual wire and overall cable shielding

### SWING-ARM SHIELD SOCK TERMINATION OPTIONS, STANDARD SPLIT RING OR STARSHIELD STAR

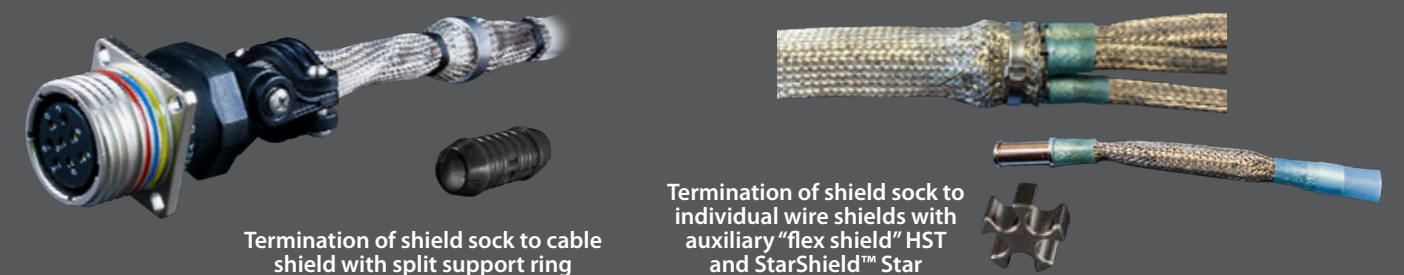

Termination of shield sock to cable shield with split support ring

Termination of shield sock to individual wire shields with auxiliary "flex shield" HST and StarShield™ Star





# ZONE 8 Cabin Interior Volume

Pressurized zone with flammability, smoke, and toxicity requirements

Commercial airplane interior volume encompasses passenger seating, electronically-controlled dimmable windows, passenger service units, galleys, lavatories, emergency lighting, in-flight entertainment, seat power, and other electrical power applications. Strict requirements must be adhered to regarding use of materials that contain halogens or other toxic elements to ensure passenger safety in the event of a fire.

Zone 8 Application Guidelines	
Environmental Stress Factors	Applicable RTCA/DO-160 Requirements
Vibration	DO-160 Category S and H (Table 8-1)
Shock	DO-160 Category A, Test Procedure 1
Ground Survival Temperature	-65° to 95°C; DO-160 Category A3 (Table 4-1)
Pressure Differential	Sea level to 10kft; DO-160 Category A3 (Table 4-1)
Operating Temperature	-55° to 85°C; DO-160 category A3 (Table 4-1) with Temperature change rate per DO-160 Category A (10°C min per minute)
Moisture	Exposure to humidity and condensation; DO-160 Category B

### Dummy Contact Sealing Plugs (DCSP)

- For reliable sealing of unused contact cavities—without the use of electrical contacts
- Ideally suited for Zone 8
- Powerful tool in EWIS weight reduction
- Leverages connector contact clip for secure retention of the sealing plug—no FOD
- Easy-to-install single piece design
- Visible quality control / confirmation of cavity fill from back of connector
- EWIS compliant test report available, ref. GT 15-106

## ZONE 8 Cabin Interior Volume

Glenair standard and signature interconnect technologies

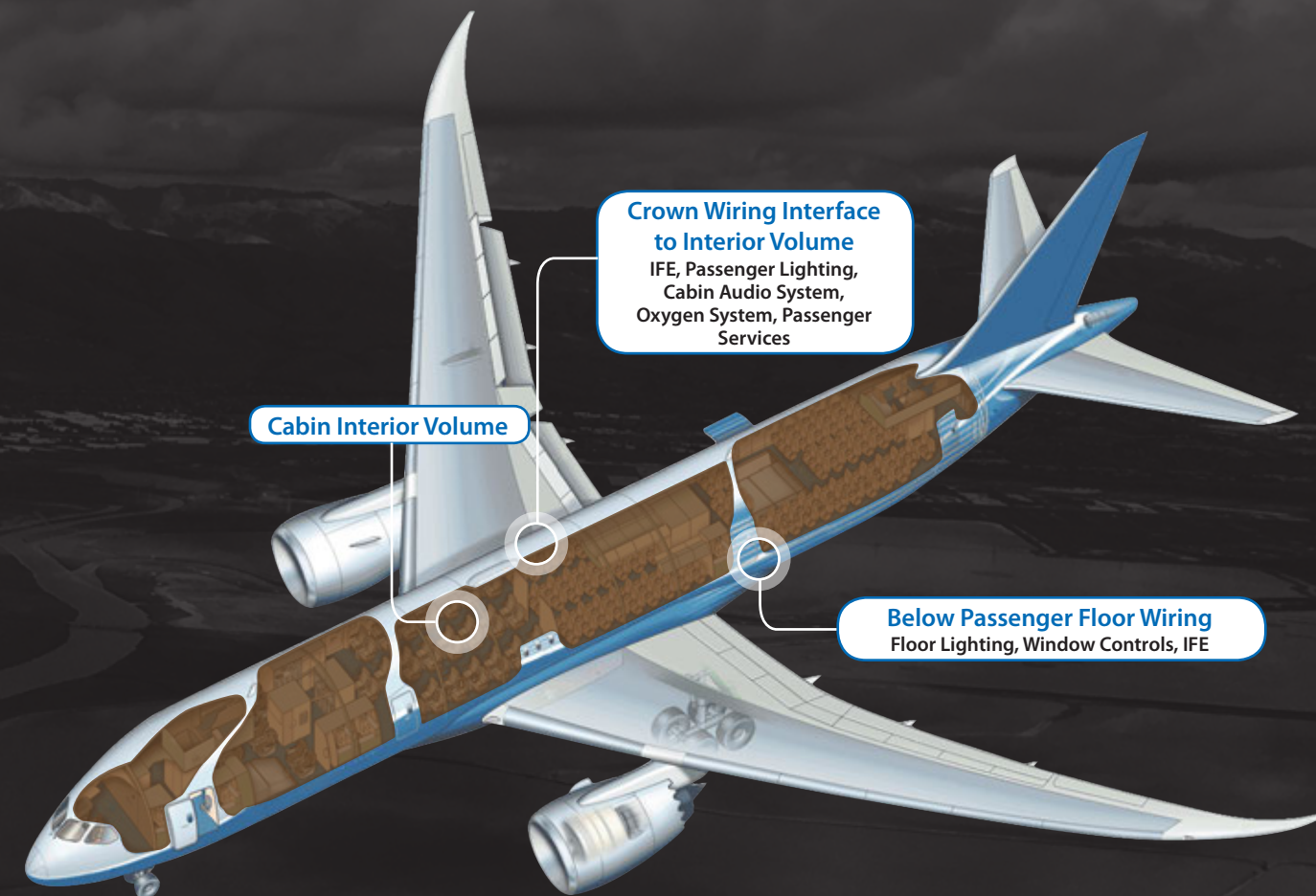

### Qualified Glenair Technologies for Zone 8: Cabin Interior Volume

- MIL-DTL-38999 Series III QPL
- SuperSeal™ RJ45 and USB 2.0
- MIL-DTL-38999 Series III Fiber Optics
- Series 806 Mil-Aero High-Performance Ultraminiature
- Series 806 Mil-Aero Fiber Optics
- AS39029 signal / high-speed contacts
- DCSP Dummy Contact Sealing Plugs
- ProSeal™ spring-action protective covers
- Advanced rectangular aviation backshells
- Connector protective covers
- Swing-Arm FLEX® composite backshells
- Band-Master ATS® shield termination system
- ArmorLite™ lightweight microfilament EMI/RFI braid
- ArmorLite™ ground straps
- MasterWrap™ wraparound EMI/RFI shielding
- SpliceSaver™ connectors
- Hermetic connectors
- Polymer-Core Conduit



WEIGHT AND  
COST SAVING  
CONNECTOR DCSPs

## Weight / Cost-Saving Dummy Contact Sealing Plugs (DCSP)

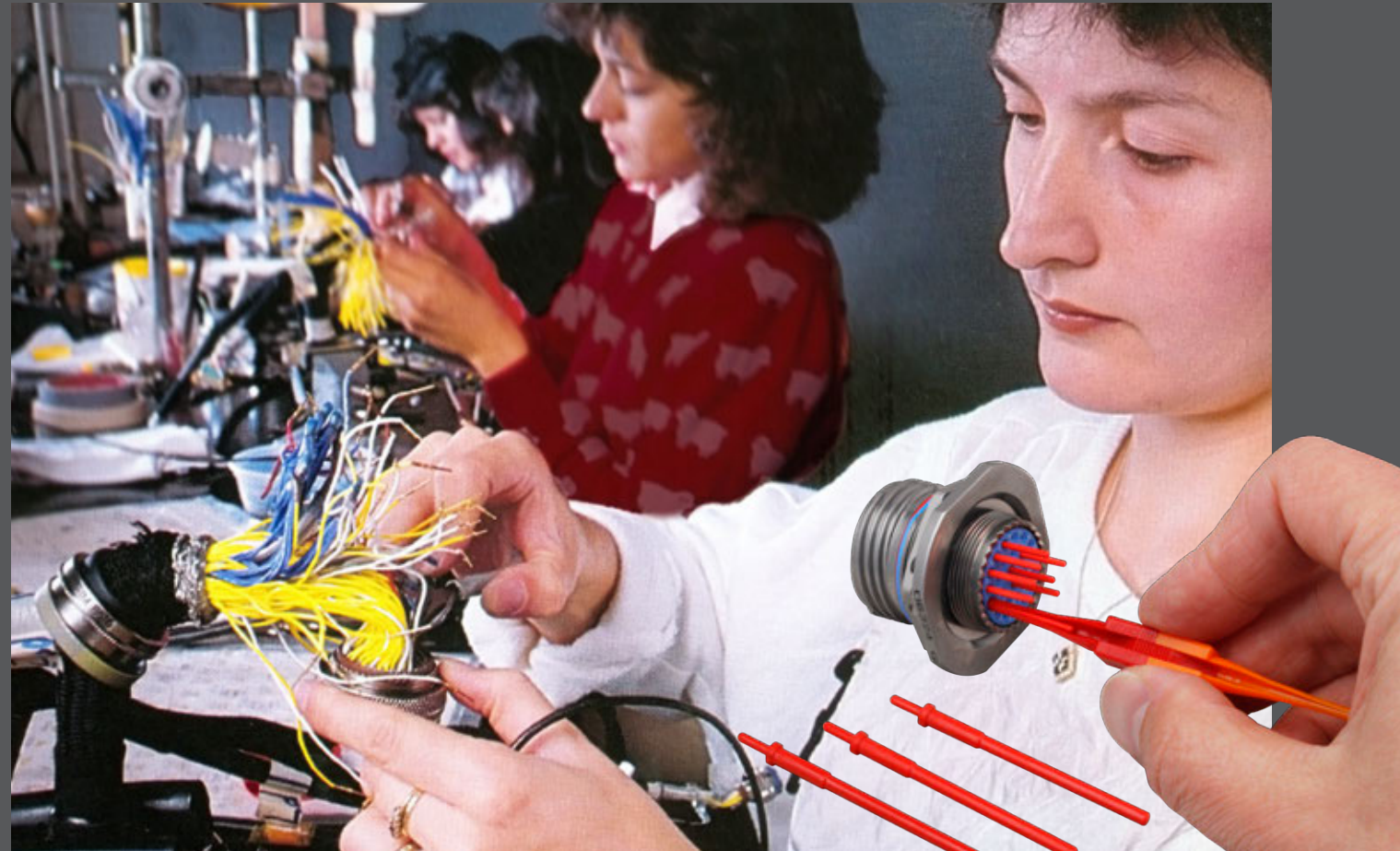

### For reliable sealing of unused contact cavities—without the use of electrical contacts

The use of color-coded M27488 type plastic sealing plugs in unused contact cavities is a requirement in all environmental interconnect applications (IAW NA01-1A-505-1, WP 007 00 or 020 00). Conventional sealing plugs, combined with the connector grommet seal, provide reliable dust and moisture ingress protection. But common contact sealing plugs still require that a properly-sized electrical contact be first inserted into the cavity, followed by the plastic plug. Glenair innovative Dummy Contact Sealing Plugs (DCSP) eliminate the need to use expensive electrical contacts as part of the sealing regimen. Fast and easy-to-install, these longer form-factor Dummy Contact Sealing Plugs (DCSP) are a one-piece solution to contact cavity sealing that results in significant weight reduction, material cost reduction, and assembly labor. Available in Size #22 to Size #8, for connector series D38999, EN4165, Series 800 Mighty Mouse, EN4644 and ARINC 600, Glenair Dummy Contact Sealing Plugs reduce weight as much as 90% compared to conventional contact/sealing plug configurations.

- Powerful tool in Electrical Wire Interconnect System weight reduction
- Eliminates use of expensive electrical contacts for sealing-only applications
- Leverages connector contact clip for secure retention of the sealing plug—no FOD
- Easy-to-install single piece design
- Visible quality control / confirmation of cavity fill from back of connector
- EWIS compliant test report GT 15-106 available

## ZONE 8 FEATURED TECHNOLOGY Dummy Contact Sealing Plugs (DCSP)

GLENAIR  
**QwikConnect**

For reliable sealing of unused contact cavities  
Saves cost and weight throughout the EWIS

Connector Series / Size / Color Code / Part Number Selection							
Connector Series	Crimp Removable Contact Cavity Size						
	23	22	20	16	12	8	8 w/ Boot
D38999 Series I, III, IV	680-116-23	680-116-22	680-116-20	680-116-16	680-116-12	680-116-8	680-116-8B
D38999 Series II							
EN4165							
Series 800-805 Mighty Mouse							
EPX		680-116-22	680-117-20				
ARINC 600						680-117-8	680-117-8B
Series 806 Mighty Mouse Mil-Aero		680-120-22HD	680-120-20HD				



### INSTALLATION OF DUMMY CONTACTS

1. Insert Dummy Contacts into unused contact cavities.
  - A. Dummy Contacts may be installed using contact insertion tool, needle nose pliers or by hand (space permitting).
  - B. Isopropyl alcohol may be used to facilitate insertion of Dummy Contacts.
2. Push Dummy Contact into cavity until flange locks into contact retention clip.
3. Attempt to pull Dummy Contact from connector body to ensure full retention.

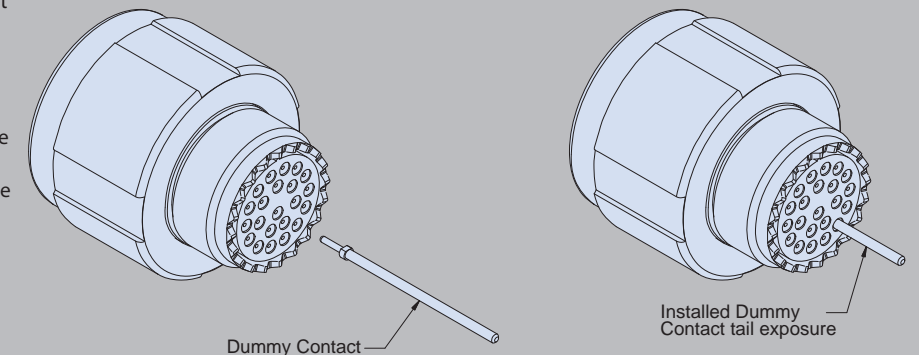

**Important note: Size #22 Dummy Contacts In 38999 socket cavities**

4. Dummy Contact shall only be inserted into cavity far enough to engage retention clip.
5. Pull Contact back for maximum tail exposure.

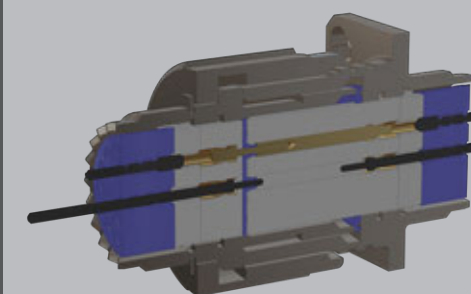
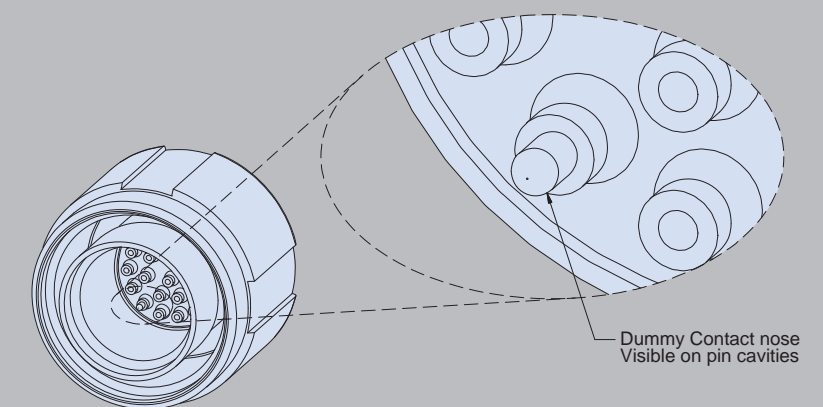

Illustration shows conventional sealing plug / contact configuration (top) and long form-factor Dummy Contact Sealing Plugs (bottom).



Dummy Contact nose Visible on pin cavities



# Outlook

## Available Steering Wheel

One of my colleagues at Glenair is in the market for a new car and, unlike me, is genuinely interested in a self-driving or at least semi-autonomous vehicle. I suppose that someday climbing into an automobile with no operator will seem no different than say, climbing aboard a driverless metro train or—looking back even farther in time—into an elevator with no human operator. But one's outlook in life is unavoidably a product of experience and circumstance. Which is why our (okay, my) nervous system is anchored in a time and place where cars without steering wheels exist in nightmares, not out on the Southern California freeways.

Being in the interconnect industry, we get exposed to all kinds of next-generation technology—a great deal of which will be put to use to realize the dream of driverless cars. And yes, I accept that GPS, radar, LIDAR, sonar, and other sensing technologies will theoretically make such vehicles as safe as my toaster oven. But, (and here is the dilemma) there is a passage from Will Durant's *The Lessons of History* that has always informed my worldview; one I think everyone should bear in mind in their unbridled enthusiasm for radical new technology,

*"Out of every hundred new ideas, ninety-nine or more will probably be inferior to the traditional responses which they propose to replace. So the conservative who resists change is as valuable as the radical who proposes it—perhaps much more as the roots are more vital than grafts. It is good that new ideas should be heard, for the sake of the few that can be used; but it is also good that new ideas should be compelled to go through the mill of objection, opposition, and contumely [Ed: ridicule]; for this is the trial heat which innovations must survive before being allowed to enter the human race".*

I believe I've already used this forum to share the story of steam locomotive manufacturing in America, as a cautionary tale that we would be wise to observe in our own industry. The Reader's Digest version is that not one of the big three steam locomotive makers successfully transitioned to the manufacture of diesel locomotives. Instead, they stayed anchored in their comfort zone of producing steam-powered locos (this despite the clear fact that their customers preferred the new, lower-cost diesels). Ultimately, new entrants in the marketplace made the transition to diesel and ran the old companies out of business.

So there is the dilemma in a nutshell. Most successful organizations begin life with a healthy attitude towards change. But over time, circumstances and experience leave them so anchored in the past that they lose the ability to imagine any kind of future other than the one they know. Can't happen here? Don't bet on it. That's why I'm going to bite my tongue and climb into a driverless car as soon as they are available. I just hope they throw me a bone and put a steering wheel in it.

*Chris Toomey*

# QwikConnect

GLENNAIR • Volume 23 • Number 2

## Publisher

Christopher J. Toomey

## Managing Editor

Marcus Kaufman

## Editor/Art Director

Mike Borgsdorf

## Graphic Designer

George Ramirez

## Technical Consultant

Jim Donaldson

## Issue Contributors

Tony Castelli

Guido Hunziker

Bob Johnson

Jim Plessas

Troy Sweet

Mike Wofford

## Distribution

Terry White

To subscribe or unsubscribe,  
please contact Terry White:  
twhite@glenair.com

QwikConnect is published quarterly by Glenair, Inc. and printed in the U.S.A. All rights reserved. © Copyright 2019 Glenair, Inc. A complete archive of past issues of QwikConnect is available on the Internet at [www.glenair.com/qwikconnect](http://www.glenair.com/qwikconnect)

## GLENNAIR, INC.

1211 AIR WAY  
GLENDALE, CA 91201-2497  
TEL: 818-247-6000  
FAX: 818-500-9912  
E-MAIL: [sales@glenair.com](mailto:sales@glenair.com)  
[www.glenair.com](http://www.glenair.com)

