

The widest range of
mission-critical interconnect
technologies in the world

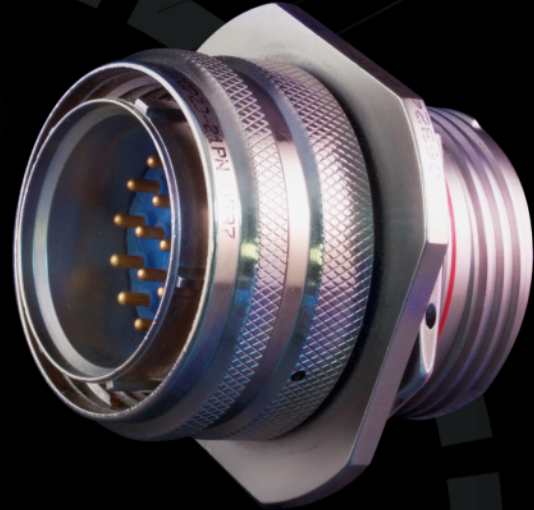
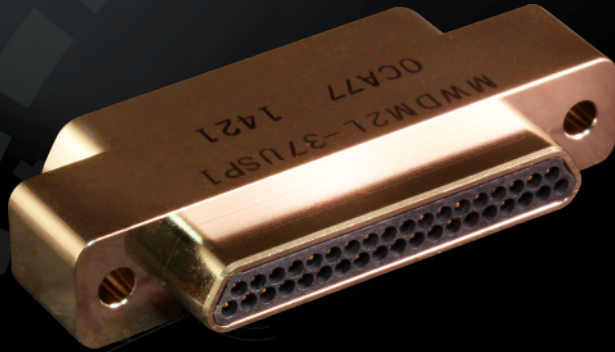

SAV-CON[®] Connector Savers

SAV-CON[®] Connector Savers

The smart solution for preventing contact damage and extending the service life of cable assemblies and mounted receptacles

- Durable “go-between” connection device
- Traditional plug-receptacle savers, as well as in-line versions and gender changers
- Available EMI/EMP filter savers and adapters
- Pin/pin, pin/socket, and socket/socket versions
- Optional locking mechanism (recommended for bayonet-style connectors)
- Keyed polarization available



SAV-CON[®] Connector Savers

Anatomy of a connector saver

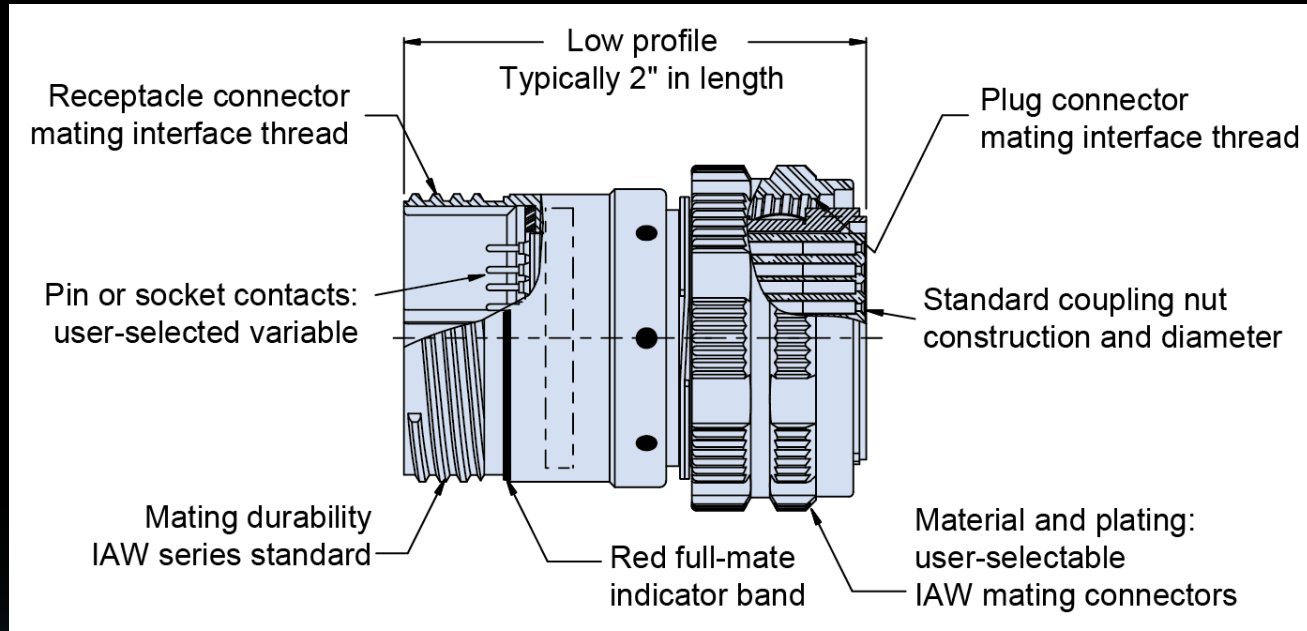

SAV-CON[®] Connector Savers

Full range of circular military-standard configurations

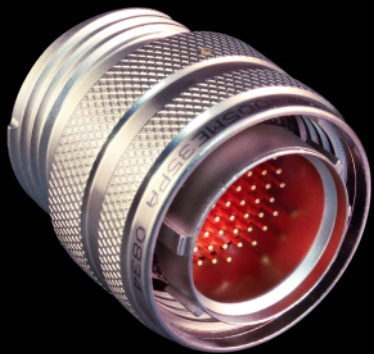

MIL-DTL-38999
Series III type



MIL-DTL-38999
Series II type



MIL-DTL-5015 type



Series 80
Mighty Mouse

SAV-CON[®] Connector Savers

Rectangular D-Subminiature, Micro, and Nano connector series



Series 89 Nanominiature
IAW MIL-DTL-32139



Micro-D Subminiature
IAW MIL-DTL-83513

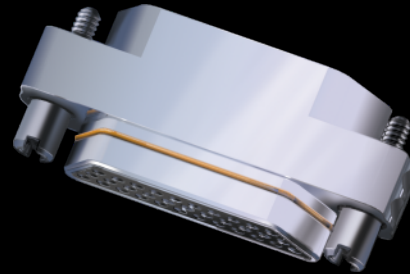

Series 79
Micro-Crimp

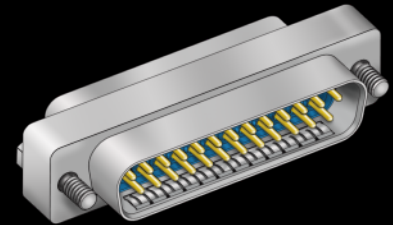

MIL-DTL-24308 type
and HiPer-D

SAV-CON[®] Connector Savers

Special applications



D38999 Sr. III type
In-Line Gender Changer



D38999 Sr. III type
Filtered Adapter

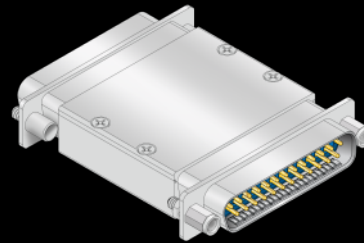

HiPer-D M24308
intermateable
Gender Changer



Micro-D and D-Sub
Filtered Adapters

SAV-CON[®] Connector Savers

Special applications



Fiber Optic Sav-Con
MIL-DTL-38999 type



Bulkhead feed-thru
Gender Changer



MIL-DTL-5015 type
Square-Flange Mount

SAV-CON[®] Connector Savers

Special application: circuit probing



- The closed-entry socket contact design permits probing for individual circuits during equipment test and check-out, preventing possible damage to the equipment connectors.

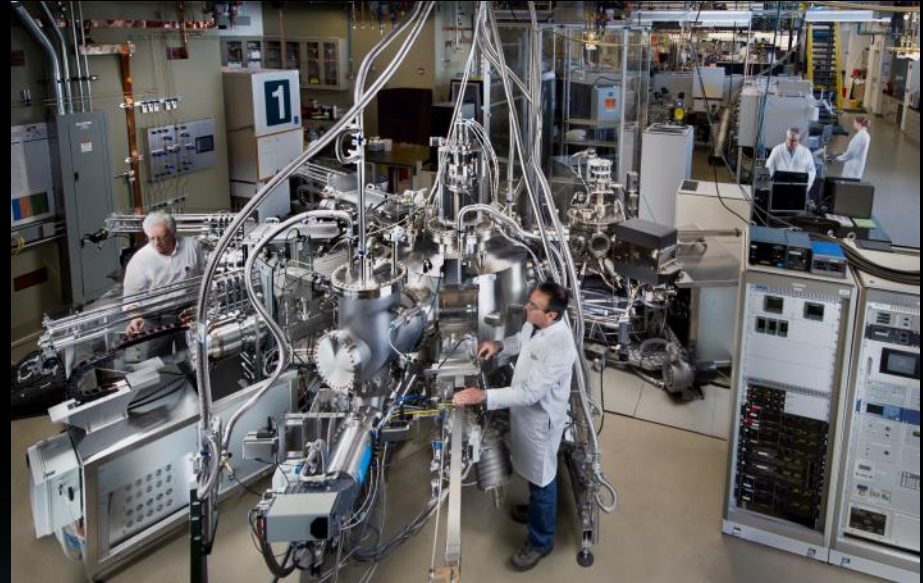

SAV-CON[®] Connector Savers



Glenair makes a Sav-Con[®] connector saver for most every military standard connector currently in use including:

- MIL-DTL-26482 Series I and II
- MIL-DTL-28840
- MIL-DTL-38999 Series I, II and III
- MIL-DTL-83723
- LN 29729 (SJT)
- PATT 105 and PATT 602
- Series 801 and 805 Mighty Mouse
- M24308 D-Subminiature
- MIL-DTL-83513
- Micro-D Subminiature
- MIL-DTL-5015
- Series 28 HiPer-D[®] M24308 intermateable
- Series 89 Nanominiature M32139
- Series 79 Micro-Crimp[®]

SAV-CON[®] Connector Savers



Mil-spec compliance

- Each Glenair Sav-Con[®] Connector Saver series meets the same durability requirements as the Military Specification series with which it mates
- The mating portions of the pin-and-socket contacts are in strict compliance with the applicable Military Specification contacts used in each connector series



SAV-CON[®] Connector Savers



Summary

- Sav-Con[®] connector savers are the smart solution for preventing contact damage and extending the service life of cable assemblies and box receptacles
- Sav-Con[®] connector savers protect connectors that are mated and unmated frequently during manufacturing, test, check-out phases, and environmental test programs
- Sav-Con[®]s prevent costly repair or replacement by absorbing connect and disconnect abuse
- Sav-Con[®] connector savers are available for all MS circular connector types, as well as for Glenair Mighty Mouse connectors, D-Subminiature and Micro-D connectors.

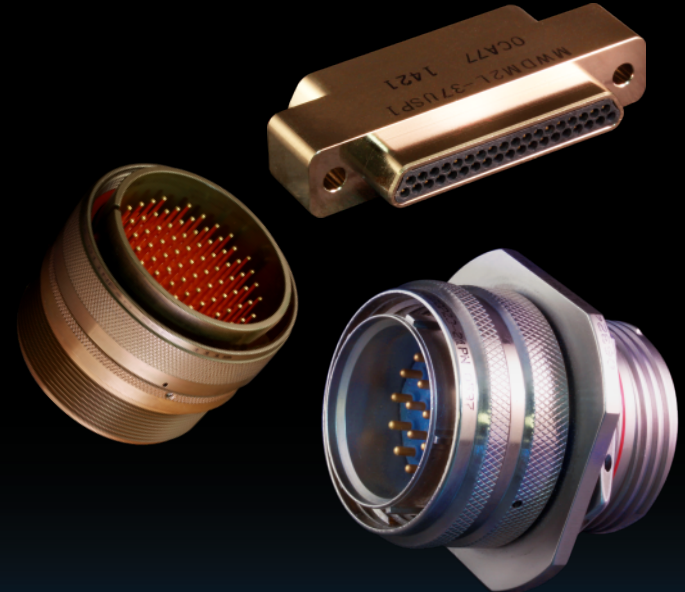

The widest range of
mission-critical interconnect
technologies in the world

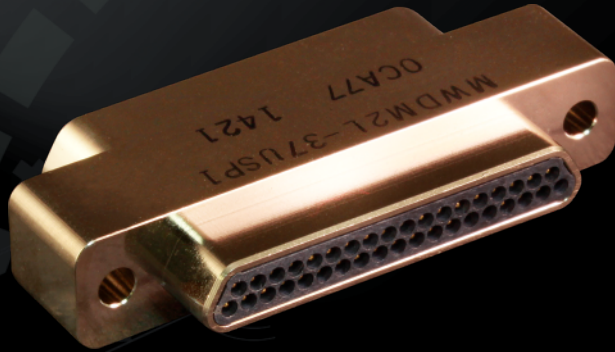

SAV-CON[®] Connector Savers