



**TURNKEY**

# **INTERCONNECT ASSEMBLIES**

**WIRED CABLE, CONDUIT, FIBER OPTICS AND FLEX**

AUGUST 2017

# SERIOUS Interconnect Cable Capabilities

**M**ilitary, aerospace, and harsh-environment industrial interconnect applications require EWIS cabling of a caliber not generally found on consumer-grade applications such as desktop computers or automobiles. In fact, the typical interconnect cable assembly made for high performance applications—from fighter jets to dismantled soldier systems—has little in common with their more pedestrian cousins in the consumer product arena including better shielding from electromagnetic interference, higher levels of environmental sealing and superior all-around mechanical performance.

## Glenair: Where Connector Manufacturing Meets Cable Harness Assembly

If there is one thing we understand well at Glenair, it's how to build interconnect assemblies for high-reliability systems. In fact, when it comes to protecting both electrical and optical media from mechanical stress, corrosion damage, lightning strike, physical abuse, nuclear, biological, or chemical contamination and more, there is no more experienced cable operation in the business than Glenair. In large part this is due to our extensive interconnect component design

and manufacturing capabilities combined with our many years of experience in military grade and harsh environmental commercial cable harness fabrication.

This special overview of Glenair's interconnect wire harness, conduit, fiber optic and flex capabilities covers the interconnect environments, materials, and design regimens that go into building high-reliability cable and conduit assemblies that meet even the most stringent electrical, mechanical, and environmental performance requirements. The montage below illustrates the many application environments where Glenair interconnect cable assemblies have proven their value and performance since 1956.

Lightweight Mighty Mouse 806 SWAMP zone sensor/transducer interconnect cable assemblies



Lightweight, flexible, abrasion-resistant power and data cables for soldier C4ISR hubs



Miniaturized space-grade harness assemblies



High-temperature tolerant reusable wire-protection conduit assembly for space launch applications



Flight-proven cable assemblies dating back to Commander Ed White's Golden Umbilical Cable, first American space walk, 1965



FADEC-caliber interconnect control box for rail engine application

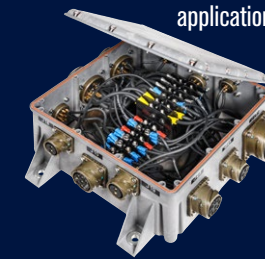

Small form-factor, flexible multibranch harness assemblies



Aircraft wheel well / landing gear wired conduit assembly

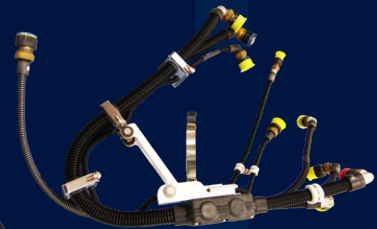

Multibranch overbraided Nomex® cable assemblies with overmolded connector junctions

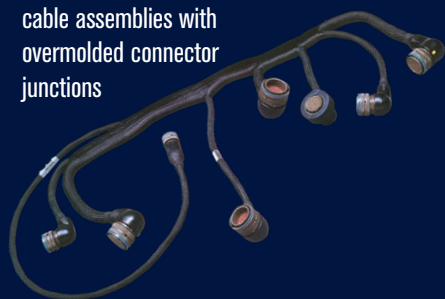

High-speed fiber optic in-flight entertainment cable jumpers



High-density power connector cables for extreme environments



Towed-array subsea streamers and overmolded cables and ROV assemblies



Corrosion-resistant wired conduit / composite junction box assembly for shipboard application

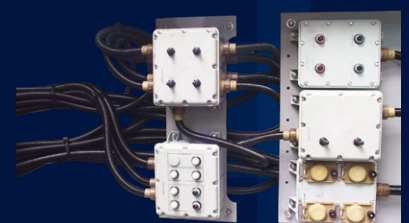

Golden Umbilical on display Smithsonian Air and Space Museum



# SERIOUS Interconnect Cable Capabilities

## Environmental and Mechanical Stress Factors that Impact Cable Design

Application environment and user mechanics define the stress factors a cable or harness must endure. "Build to print" specifications typically spell out cable assembly sealing levels, mechanical durability, shielding levels as well as preferred materials and design. Glenair's cable/harness engineering team can also suggest design ideas, material types and fabrication processes that we know from experience best meet application needs in each specific environment. Careful attention to caustic chemicals and fuel types, UV exposure and mechanical

abrasion can significantly improve cable durability. Shielding material choices that resist windowing can improve electrical grounding throughout the life of the system. The judicious use of speciality fabrication processes, such as overmolding and the banding termination of shields, result in robust cable strain relief and reduced stress on wire junctions.

## High-Speed Performance Requirements

High-speed protocol specifications also dictate material and design decisions for wires, cables, connectors, shielding, and grounding. In specialty cable assemblies, such as RF, gigabit Ethernet and high-bandwidth fiber

optics, these many unique requirements demonstrably impact harness design and construction including length, shielding layers, and bend moment. Glenair is well known as the go-to supplier for assemblies of this type. Our complete control of component part manufacture also allows us to offer accelerated lead times, improved quality control, and advantageous pricing on a complete range of assemblies incorporating advanced EMI/RFI filter, lightweight shielding and impedance-control technologies.

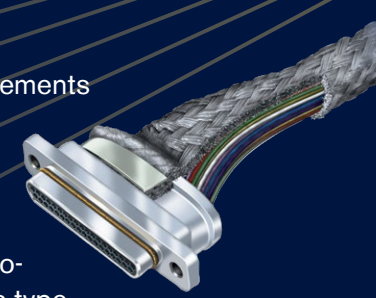

Small form-factor snap-lock, trigger-release helmet assembly with MouseBud™ spring-contact connectors



Soldier radio / C4ISR system power, voice, and data cables



Soldier-to-armored vehicle power / data interface cables and flex assemblies with SuperSeal™ field interconnects



Shallow water submersible and topside harsh-environment cable assemblies for geophysical applications



F/A-18 hybrid multibranch radar pantograph interconnect cable assembly

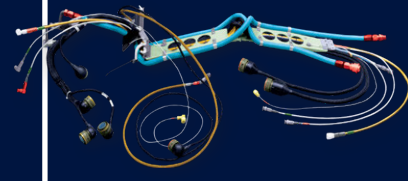

Certified laboratory and space-grade ECSS-E-ST-50-12C SpaceWire data transmission cable assemblies



Harsh-environment, field-deployable MIL-DTL-83526 type GFOCA spooled cable assemblies

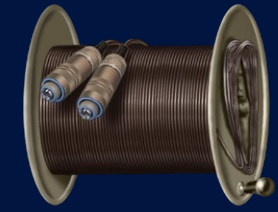

MIL-DTL-83513 Micro-D and MIL-DTL-32139 Nano missile telemetry cable assemblies



F-16 full immersion fuel tank cable assembly with molded bulkhead fittings

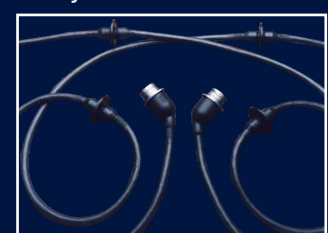

Ultra-lightweight, high-temperature PEEK wired conduit assembly, rail traction motor application



Turnkey in-house integrated flex assemblies

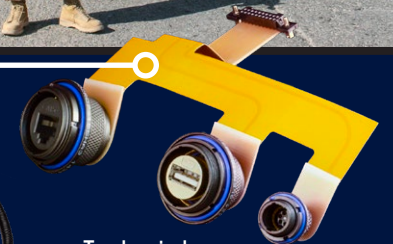

Buffer interface connector-equipped missile pylon assembly



Complex multibranch AWACS radar assembly

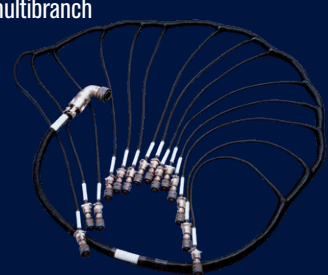

Pure air interconnect assembly for infrared detectors and other cryogenic cooling applications





# COMPLEX CABLE Assemblies

Terminated, tested, and ready for use, Glenair complex cable assemblies may be supplied with MIL-M-24041 overmolding materials such as Viton®, Duraelectric™, polyurethane, EPDM, Santoprene™, polyamide and more. Rugged overbraided assemblies for superior mechanical protection and flexibility are also a specialty. Fast turnaround and quality fabrication in complex cable assemblies depends on capital investment in tooling, injection molding equipment, planetary wire stranders, braiding machines and more.

## Advantages of Overmolding

- Waterproof sealing
- Robust mechanical protection
- Permanent protection of terminations
- Resistance to chemicals and fuels
- No induced cold flow stress
- Electrical isolation and insulation
- Reduced damage from wear
- Flexible routing/cable entry
- Repeatable assembly performance



Color-coded overmolded power and signal cable assembly



Overmolded TurboFlex™ power and signal tank pylon assembly

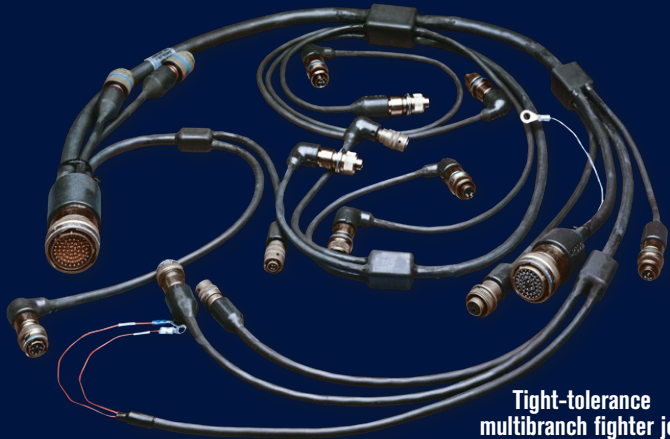

Tight-tolerance multibranch fighter jet assembly



Repairable accordion boot-equipped assembly

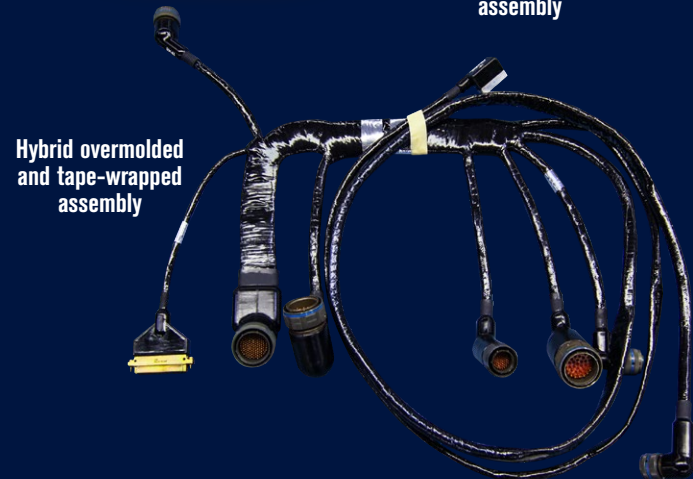

Hybrid overmolded and tape-wrapped assembly



Overmolded point-to-point assembly with coil cord cabling

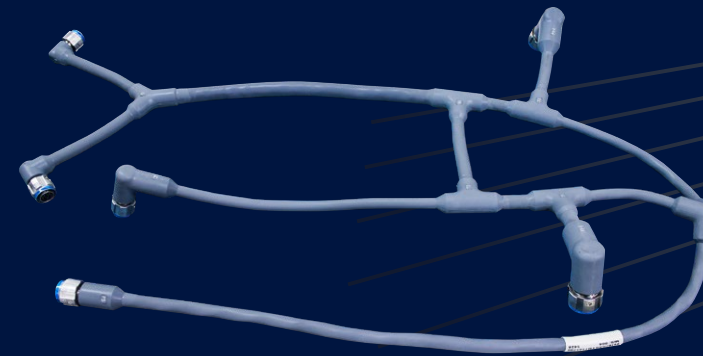

Commercial aircraft assembly with Duraelectric™ overmolding and Mighty Mouse connectors

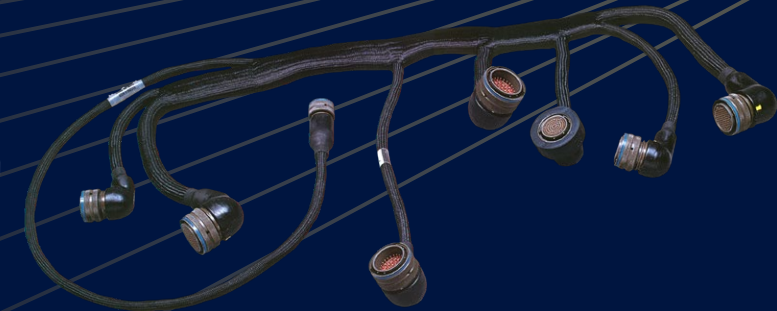

Hybrid abrasion-resistant overbraided cable assembly with overmolded cable junctions

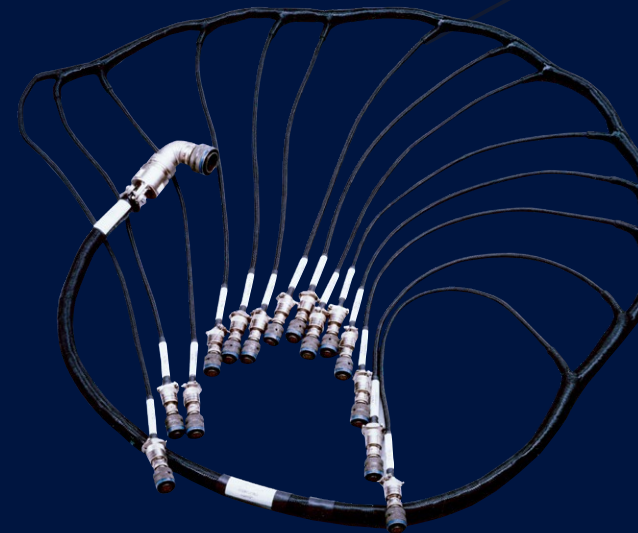

Complex multibranch aerospace assembly equipped with removable backshells for easy field repairability

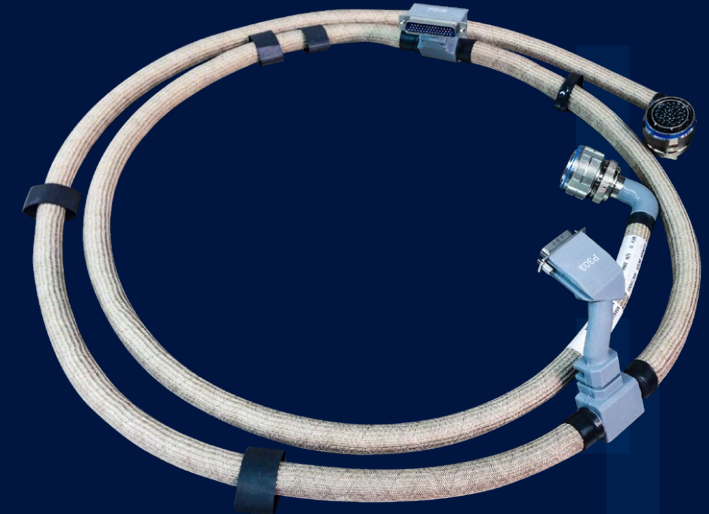

Fabric overbraided assembly with discrete overmolded interconnect standoffs



Lightweight microfilament (ArmorLite™) EMI/RFI shielded assembly for a non-environmental aerospace application



Hybrid fabric overbraided assembly with overmolded bracket mounts and wire-to-connector junctions



# FIBER OPTIC Assemblies

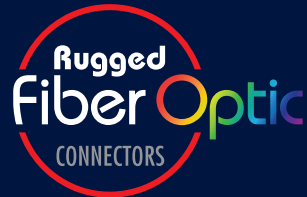

Glenair manufactures every mission-critical fiber optic interconnect system including MIL-DTL-38999 type, MIL-DTL-64266 NGCON, MIL-PRF-28876, ARINC 801, and more. Our turnkey fiber optic cable assembly team can integrate each fiber optic connection system with appropriate, termini, backshell accessories, and in-house produced cables into finished assemblies—terminated, tested, and ready for immediate use. Examples shown below range from inside-the-box pigtail assemblies to harsh environment fiber optic cables, junction boxes, and integrated assemblies.

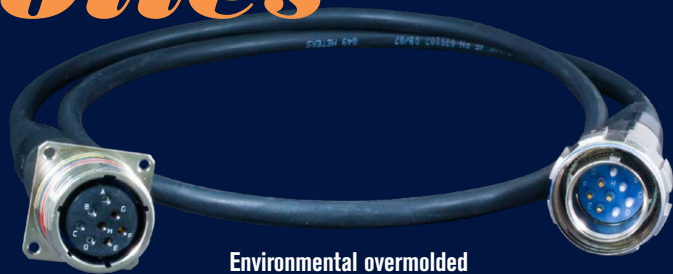

Environmental overmolded fiber optic cable assembly, MIL-DTL-38999 type with 29504/8 /9 QPL termini



Hybrid MIL-DTL-38999 series III type fiber optic / electrical cable junction box

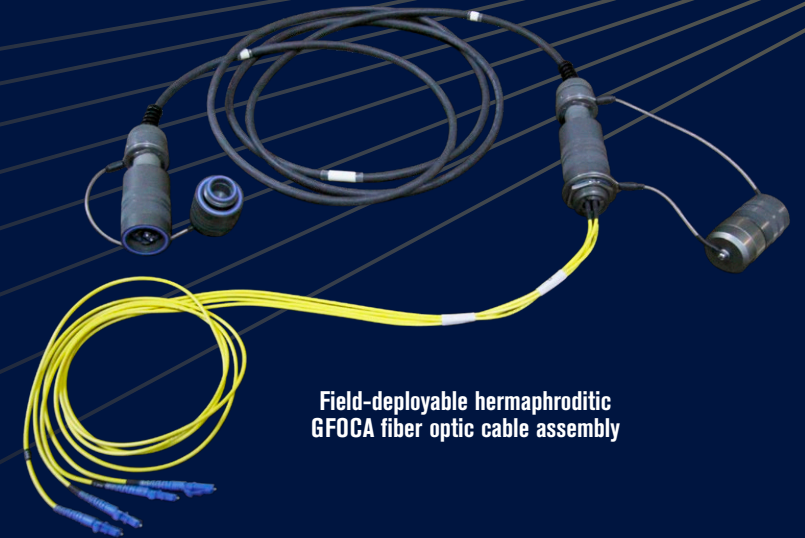

Field-deployable hermaphroditic GFOCA fiber optic cable assembly



Harsh environment overmolded MIL-DTL-38999 Series III type composite



Commercial-grade jumpers for non-environmental applications

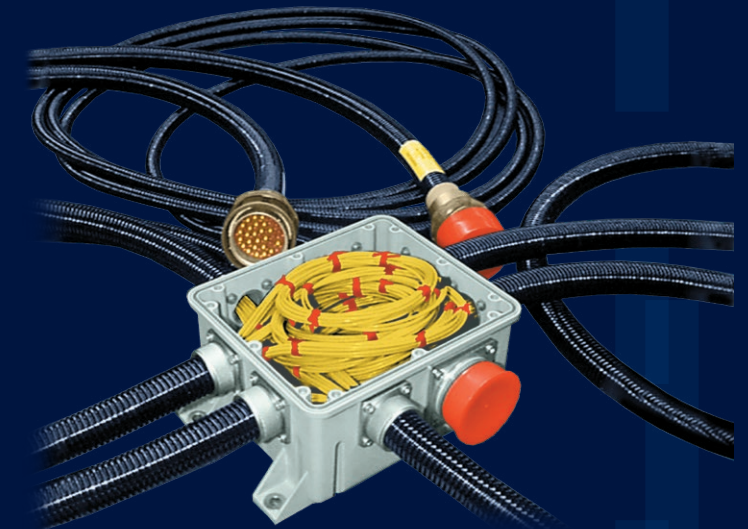

Fiber optic multibranch assembly with flexible conduit wire protection and integrated cable storage bay



Multi-way inside-the-box D38999-to-ST assembly



Cable reels and field-deployment technologies for both Glenair GFOCA and Eye-Beam® GMA fiber optic systems



Harsh environment repairable MIL-DTL-38999 Series III type with FiberCon backshell to prevent fiber media damage



High-density non-environmental fiber optic assembly



Point-to-point fiber optic cable with integrated strain relief



Glenair offers turnkey fiber optic maintenance kits and on-site fiber optic technician certification training



Demo assembly illustrating MT fiber optic board terminations



GFOCA I/O to board assembly with reinforcing overbraiding



Inside-the-box MIL-DTL-38999 type I/O connector to board





# GROUND SOLDIER Assemblies



Glenair STAR-PAN™ USB hub and power distribution interconnect systems are optimized with embedded power conditioning and charging electronics which allow the hub to utilize both primary battery power as well as scavenged power from direct current sources.

Dedicated adapters and cabling for all charging functions as well as interconnect cabling for the broad range of soldier peripherals, radios, and computer EUDs are also supplied. Glenair STAR-PAN™ system cables utilize field-proven Mighty Mouse Series 804 connectors, and are optimized for durability, flexibility, and environmental sealing.

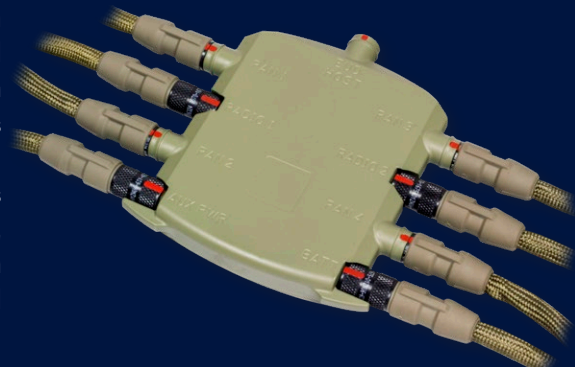

## General-Purpose STAR-PAN™ System Cables



NETT Warrior (C1) Extension Cable 808-047



Host USB-A Cable 808-079



C4 Micro USB EUD Host Cable 808-046

## STAR-PAN™ Peripheral Device Cables



TacROVER-e Cable 808-043



Radio Adapter Cable 808-080



USB 2.0 Adapter Cable 808-053



DAGR GPS/Navigation Cable 808-040



TacROVER-p ISR Receiver Cable 808-045

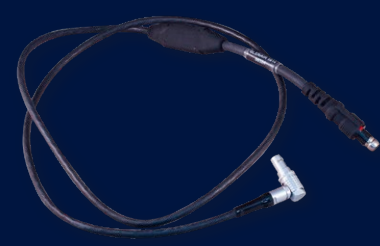

PLRF-15C/25C Laser Range Finder Cable 808-049

## STAR-PAN™ Radio Data / Power Cables and Adapters



Microlight Radio Data Cable 808-044



PRC-117G Radio Data Cable 808-035



Harris Radio Adapter Cable 808-088



PRC-148 Radio Data Adapter 808-039



PRC-152A Radio Data Adapter 808-032



PRC-154 Rifleman Radio Data Adapter 808-051

**Small form-factor tactical soldier interconnect cable assemblies with Series 804 Mighty Mouse quick-disconnect connectors**



**Harsh Environment Overmolded**



Overmolded breakout assembly featuring 100% Glenair content; a true turnkey solution

**Ultraflexible Fabric Overbraid**



Non-environmental aircraft cable with integrated circuit breakout box and Mighty Mouse 804 push-pull connectors



Multibranch cable assembly with Glenair Mighty Mouse, HiPer-D M24308 and customer-supplied power connector



Heads-up display (HUD) cable with custom Series 804 Mighty Mouse and low-profile cable routing



Turnkey overmolded GPS cable assembly with integrated switch



Military jet jumper cable with user-serviceable backshells and fabric overbraid for mechanical protection



Environmental cable with Glenair Series 804 Mighty Mouse, Series 79, and RF Coax terminations



Hybrid Mighty Mouse and Micro-D aircraft pilot helmet cable assembly



# WIRED CONDUIT Assemblies



## CONDUIT SYSTEMS

### Rugged, lightweight, flexible solutions

All of the metal-core conduit and polymer-core convoluted tubing systems we fabricate at Glenair may be wired and assembled at our factory with tamper-proof crimp ring or solder terminations according to customer requirements.

Reduced size and weight factory terminated conduit assemblies—from simple point-to-point to elaborate multibranch configurations—offer the utmost in environmental ruggedness, reliability and durability. Certified factory assemblers and calibrated tooling guarantee reliable long-term performance.

Glenair's expertise in wired conduit systems extends from simple point-to-point jumpers to complex multibranch assemblies as well as turnkey integrated systems and LRUs with flexible conduit interconnect cabling.

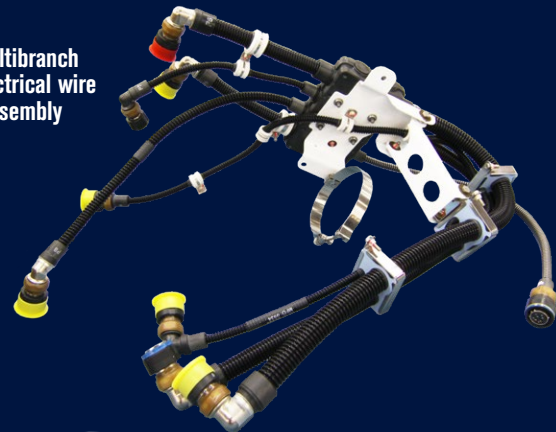

Complex multibranch fighter jet electrical wire conduit assembly



Turnkey integrated box assembly and wired polymer-core interconnect system with NAVSEA-qualified Navy junction boxes



Multibranch demo assembly: left: stainless steel metal-core overbraided; middle: polymer-core abrasion protection; and right: high-temperature, halogen-free PEEK



Lightweight, halogen-free rail industry wire conduit assembly

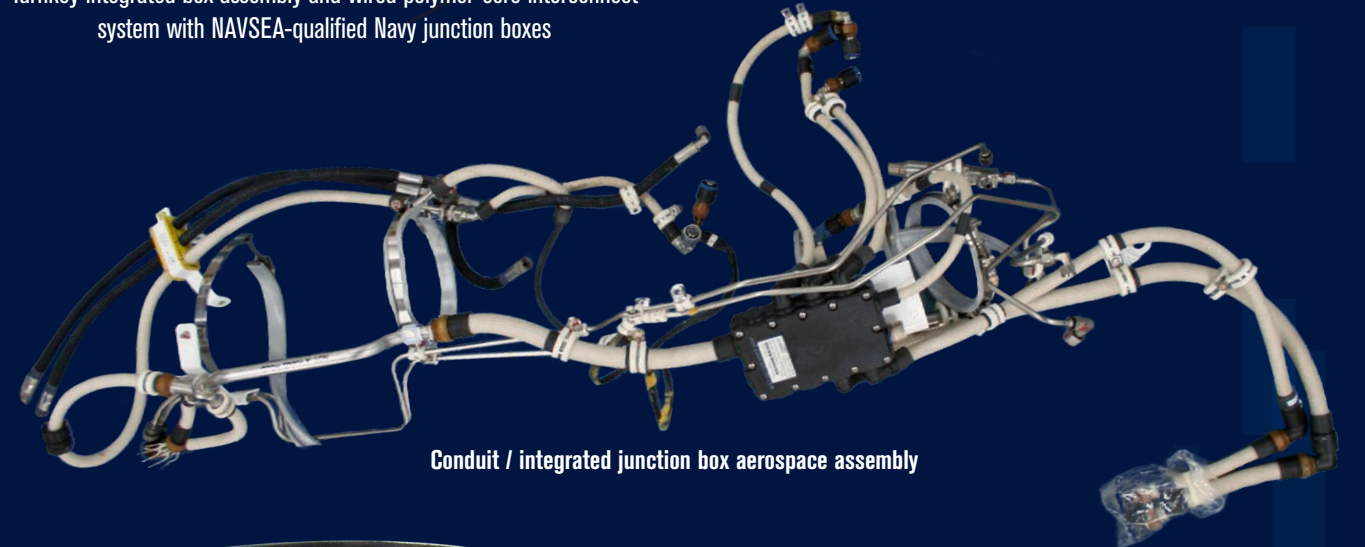

Conduit / integrated junction box aerospace assembly



Lightweight multibranch wire protection conduit / box assembly with high-temperature polymer-core convoluted tubing



Crush-resistant commercial aerospace metal-core conduit assembly



Splash zone, above-deck shipboard conduit assembly with Marine Bronze Geo-Marine connectors

High-performance electric vehicle power-train conduit assembly

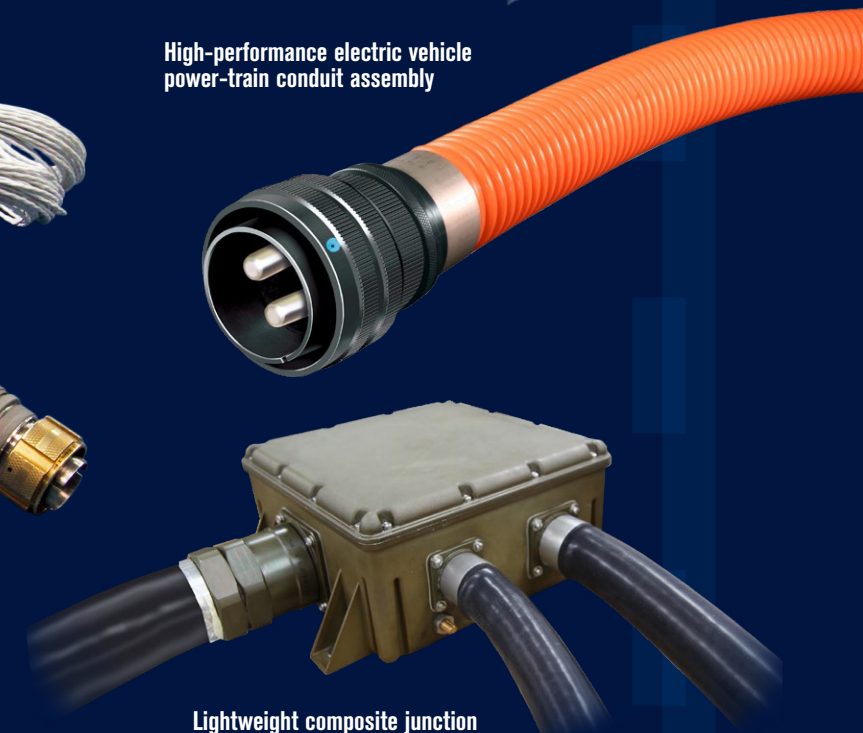

Lightweight composite junction box and polymer core conduit wire protection assembly



Ultra-flexible polymer-core fiber optic conduit assembly



# RECTANGULAR Assemblies

Rectangular connectors deliver optimized interconnection of circuits with higher-density and less wasted space compared to circulars. Efficient use of space goes hand-in-hand with contact density to enable rectangular shaped connectors to better fit into reduced size and weight applications. Because of their overall shorter length, lower shell profile and the fact that rectangulars do not need as much adjacent space for manual mating and de-mating, they are typically the connector of choice for low profile devices such as backplane and blade-type applications.

Glenair manufactures the complete range of rectangular connectors and connectorized interconnect assemblies from Nano and Microminiature to larger form-factor M24308 D-Subs and filtered ARINC 400 / 600.

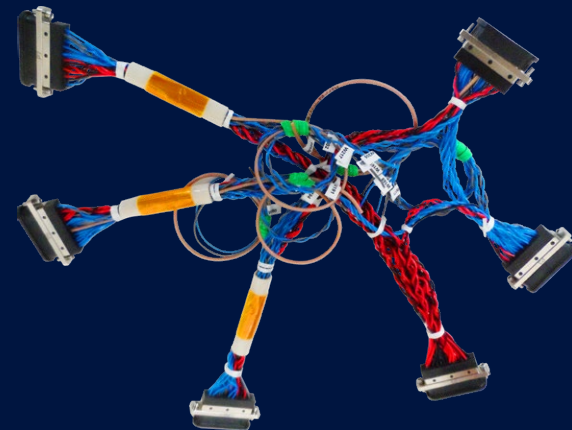

Open-loom Micro-D wire harness for an industrial robotic application



Hybrid Nano circular, D-Sub, and RF overmolded cable assembly

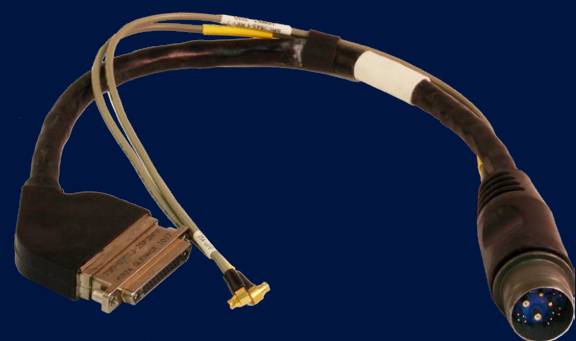

High-speed / RF cable assembly with overmolded Series 79 I/O connector and Mighty Mouse quick-disconnect cable connector

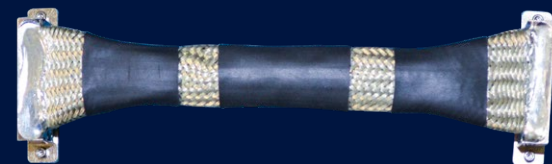

Back-to-back shielded Micro-D assembly

▲ Circular/rectangular assembly with custom breakout junctions and low-profile broom stitch cabling

▶ Micro-D assembly with machined chassis and custom connector packaging

**HiPer-D, Micro-D, Nanominiature, and Series 79 Interconnect Assemblies: Factory-Terminated and Ready for Immediate Use**

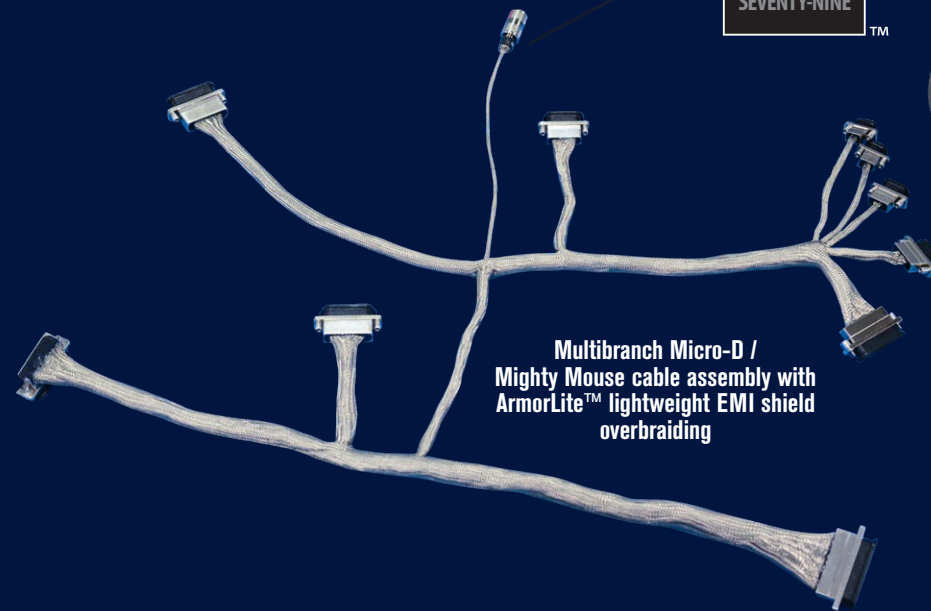
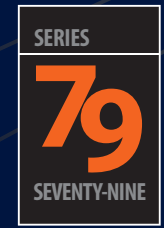

Multibranch Micro-D / Mighty Mouse cable assembly with ArmorLite™ lightweight EMI shield overbraiding



Viton overmolded Micro-D to Mighty Mouse cable assembly with Series 77 Heat Shrink 3-1 transition



Repairable backshell-equipped Micro-D open loom cable assembly with MIL-DTL-28840 circulars for a US Navy application

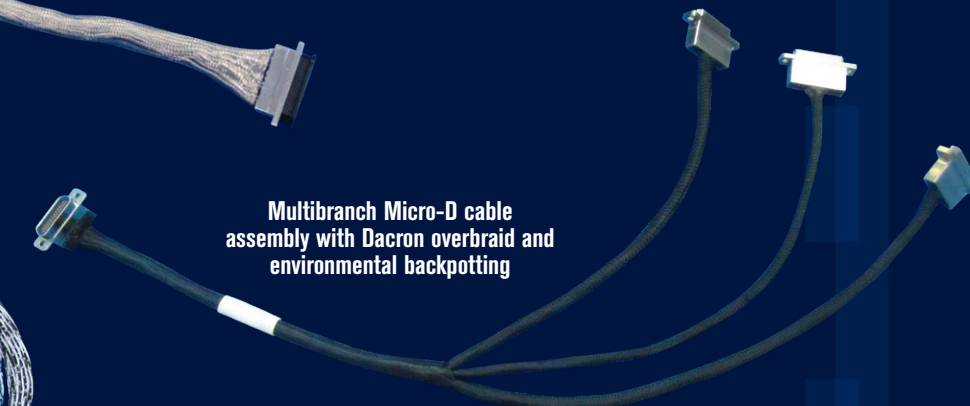

Multibranch Micro-D cable assembly with Dacron overbraid and environmental backpotting



EMI/RFI shielded multibranch Micro-D connector assembly with Glenair Series 23 SuperNine® panel mount I/O connector





# MARINE/SUBSEA Assemblies

## High pressure, up to 10K psi open-face deep water connectors, complex cables, and PBOF assemblies

All connectors and assemblies fully tested and qualified in-house in Glenair's state-of-the-art hydrostatic test lab.



Glenair's hydrostatic test lab control room: modular consoles provide for up to 8 pressure circuits, operating in manual or automated mode. Each circuit is capable of a maximum of 16.5K psi.



SuperG55 series cables undergoing qualification testing



Glenair's hydrostatic test lab accommodates pressure testing of discrete connectors as well as large multibranch assemblies

SeaKing™ PBOF hose attachment accessories feature adjustable hose routing/angle adjustment and 340° hose swivel action



SeaKing is an innovative new connector series that eliminates a broad range of mechanical design weaknesses found in many of today's high-pressure subsea connector families. From its double O-ring seals and retractable engaging nut, to its multi-keyed mating interface, the SeaKing represents a bold new approach to subsea power and signal connectivity.



Transparent overmold test sample shows Glenair's harsh-environment, high-pressure cable overmolding and termination expertise (no voids, 360° material adhesion and cosmetic perfection)



## Series 70 SeaKing™

10K PSI / 700 Bar / 7000m open-face or mated, dual O-ring equipped, high-density, high-voltage, fiber optic and hybrid electrical/optical subsea connectors.

Series 70 SeaKing™ cable assemblies are available from the factory with special 10,000 psi overmolded cable-to-plug connector environmental sealing.



Special high-speed application 10K psi overmolded 75 Ohm Coax hybrid assemblies



## Series 22 Geo-Marine®

Geo-Marine® plugs are equipped with arctic coupling nuts—made from marine-grade naval bronze—with easy-to-grip castellated knurling and a powerful ratcheted anti-decoupling mechanism which guarantees reliable mating and demating performance in even the harshest environments. Supplied as discrete connectors—or more typically in build-to-print overmolded cable assemblies—the Series 22 Geo-Marine® has delivered reliable, proven performance in high-pressure subsea applications.



Geo-Marine catalog cordset



High pressure environmental and hermetically sealed cable for a field geophysical application



Marine-grade naval bronze interconnects in an ultra harsh-environment subsea cable assembly



## SuperG55™

The SuperG55™ family of dry-mate deep sea-high pressure connectors is a revolutionary new design of the popular industry-standard used in countless ROV, underwater camera, diver communications, lights, pan and tilts, and other subsea applications.

Available in multiple shell sizes, the SuperG55™ is manufactured from 316L Stainless Steel with insert molded contact assemblies designed for pressure-sealed applications up to 10K psi mated and unmated. Intermateable and intermountable with other "55" series connectors, the Glenair solution introduces a long list of product innovations designed to improve performance and durability.



SuperG55 right-angle overmolded high-pressure 10K psi sealed cable connector plug (CCP)



SuperG55 PBOF hose attachment accessories feature adjustable hose routing/angle adjustment and 340° hose swivel action



SuperG55 Factory-terminated overmolded high-pressure 10K psi sealed cable connector plug (CCP)



# PCB/FLEX Assemblies

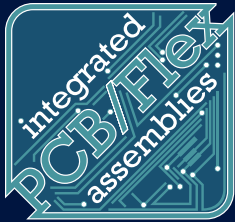

## Printed Circuit Board and Flex Circuit Interconnect Assemblies

Electrical wire interconnect designers are increasingly turning to small form-factor flex circuitry to replace board-to-I/O wiring. Glenair offers turnkey PCB/Flex interconnect design and assembly. PCB/flex circuits offer unsurpassed size and weight reduction compared to cable bundles, especially in tight spaces with multi-branch routing. Flex circuitry offers outstanding mechanical performance, being able to withstand extreme vibration environments and capable of extended duty even through thousands of flexing cycles. Replacing complicated wire bundle assemblies with high-density flex assures faster, error-free assembly.

From concept drawings and fabrication data packages, to PCB/flex fabrication and assembly, we offer a complete solution. Termination to Glenair-manufactured printed circuit board connectors ensures high quality and technical performance to even the most challenging delivery requirements.

The ability to deliver connectorized flex and rigid flex assemblies is an important enabling technology contributing to our overall embedded subsystem electronics offering. We offer IPC Class III manufacturing for multiple panel sizes and panel thicknesses up to .5 inch. A broad variety of materials are available including Polyimide, FR-4, Rogers 4003, and Isola. Available surface finishes include ENIG, HASL, Ni/Au and more. Our PCB/Flex Interconnect team offers:

- Circuit design and generation of PCB/Flex fabrication data packages
- Full component-level documentation
- Assembly drawings and BOM management
- 200+ certified PCB and cable assemblers
- IPC-6012 Class I, II, III, types 1-4; ISO 9001, AS9100
- ESD management
- NADCAP certification for special processes
- Tests such as DWV/IR, continuity, and others.
- Overmolding with multiple materials, including Hysol for PCB terminations

## Point-to-Point Connectorized Flex and Rigid Flex Jumpers

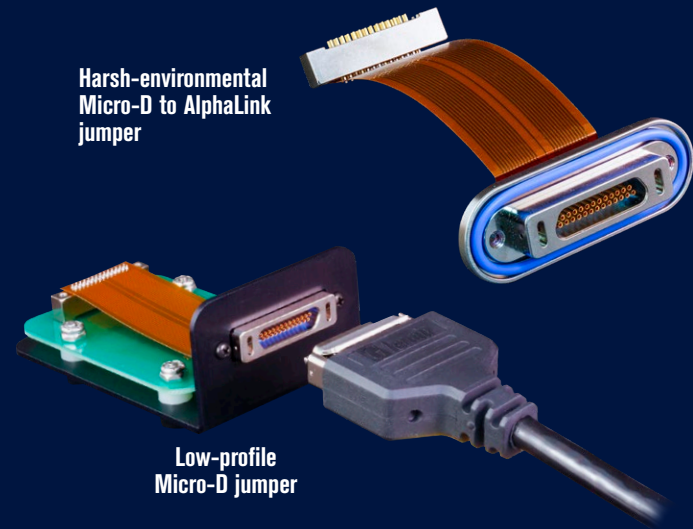

Harsh-environmental Micro-D to AlphaLink jumper

Low-profile Micro-D jumper



804 Mighty Mouse to Samtec surface mount jumper

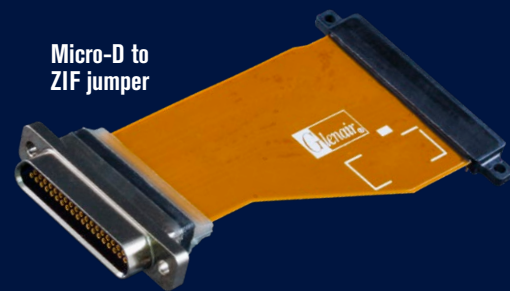

Micro-D to ZIF jumper



Bayonet receptacle connector with direct board termination flex

Series 23 SuperNine to AlphaLink jumper



Our flex fabrication cell delivers IPC 6012 and 6013 Class III manufacturing and is managed under the same ISO 9001 and AS9100 certified quality system as the rest of the Glenair operation

## Multibranch Flex and Rigid Flex Connectorized Assemblies

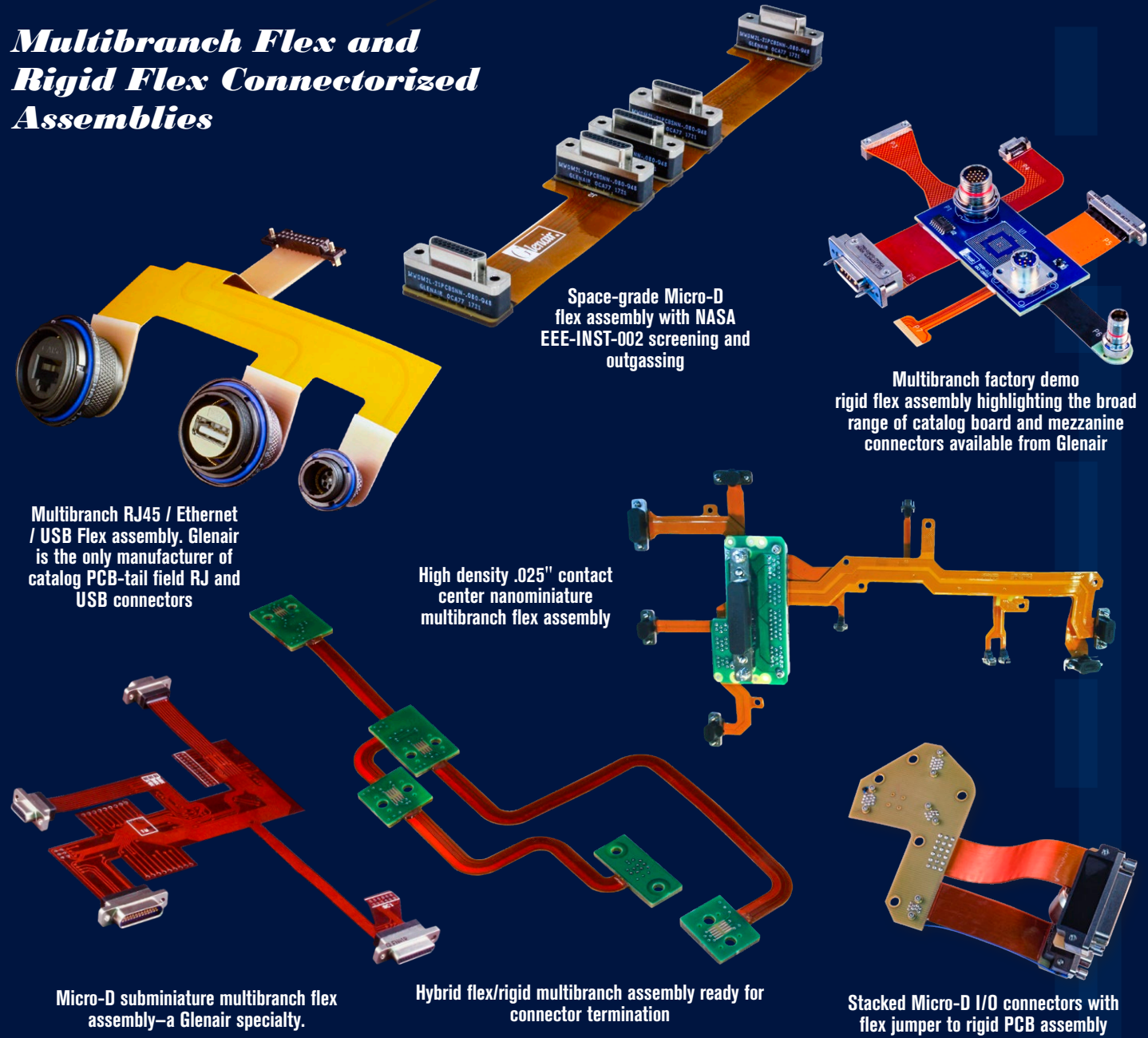

Space-grade Micro-D flex assembly with NASA EEE-INST-002 screening and outgassing

Multibranch factory demo rigid flex assembly highlighting the broad range of catalog board and mezzanine connectors available from Glenair

Multibranch RJ45 / Ethernet / USB Flex assembly. Glenair is the only manufacturer of catalog PCB-tail field RJ and USB connectors

High density .025" contact center nanominiature multibranch flex assembly

Micro-D subminiature multibranch flex assembly—a Glenair specialty.

Hybrid flex/rigid multibranch assembly ready for connector termination

Stacked Micro-D I/O connectors with flex jumper to rigid PCB assembly



# INTEGRATED Systems

## Turnkey, precision-machined structural components / enclosures plus Glenair-built interconnect cabling

Glenair, together with our precision machining partner Dynamax, is able to offer our defense and aerospace customers fast, turnkey build-to-print integrated system solutions. From landing gear assemblies to in-flight entertainment platforms, Glenair is uniquely positioned to leverage our component manufacturing, interconnect cable assembly and structural member fabrication capabilities to meet the broadest range of integrated system requirements. Our US-based factories in Glendale, California and Chicago, Illinois are FAA, Mil and ISO certified, and ready to tackle any integrated system requirement for today's high-performance military and aerospace applications. Best of all, our design and manufacturing team is ready to provide start-to-finish engineering and assembly support on every project.

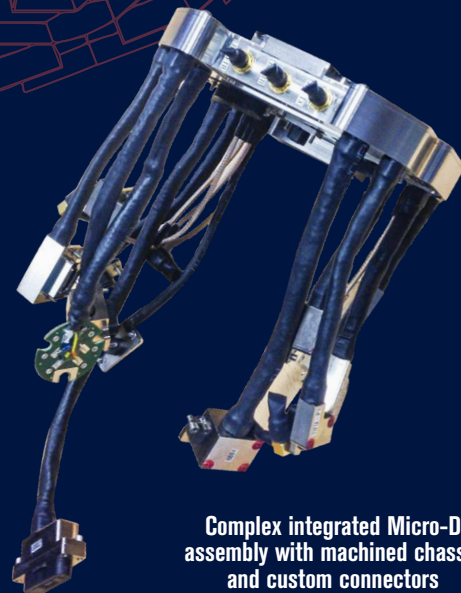

Complex integrated Micro-D assembly with machined chassis and custom connectors

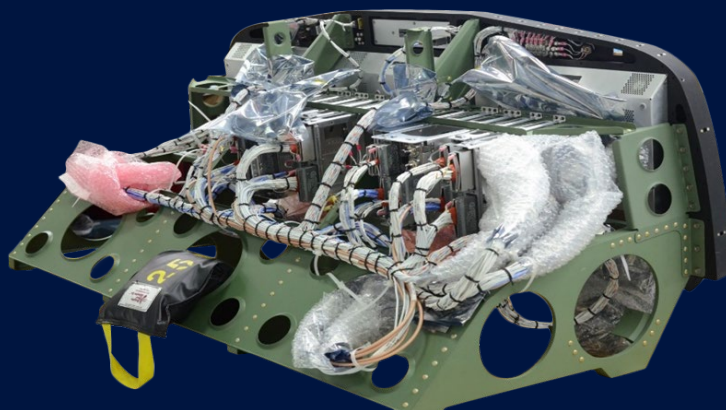

Integrated cockpit chassis and interconnect harnessing



Fully connectorized and wired power console

## Glenair integrated systems value proposition

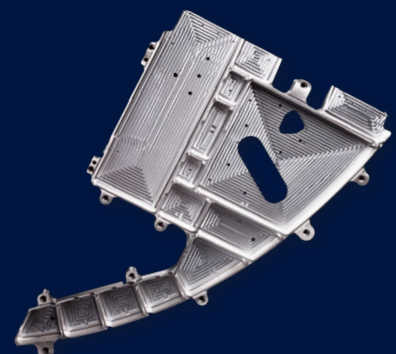

Precision-machined, injection molded or stamped-and-formed boxes and structural members

+

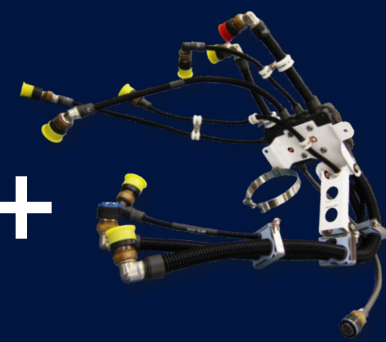

Multibranch interconnect cable harnesses and assemblies—terminated, tested, and ready for use

=



Turnkey integrated system components: Vertically integrated manufacturing, from backplanes to avionic control panels

Turnkey complex cable assemblies • junction boxes  
avionic control panels • connectorized backplanes

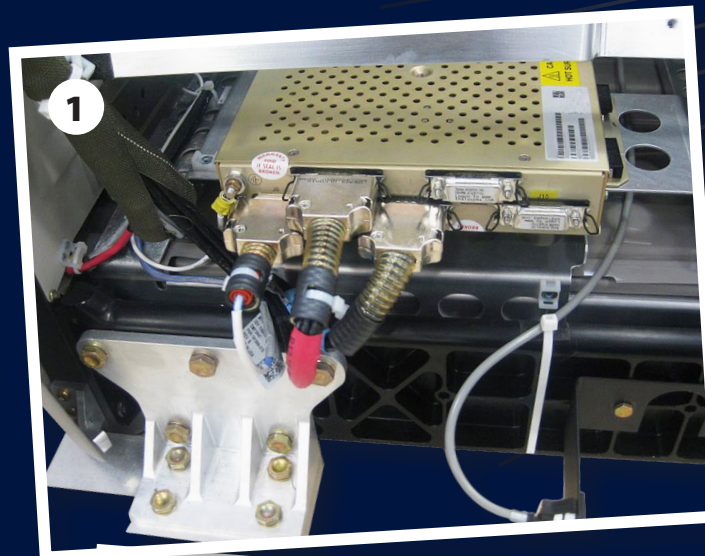

1



2

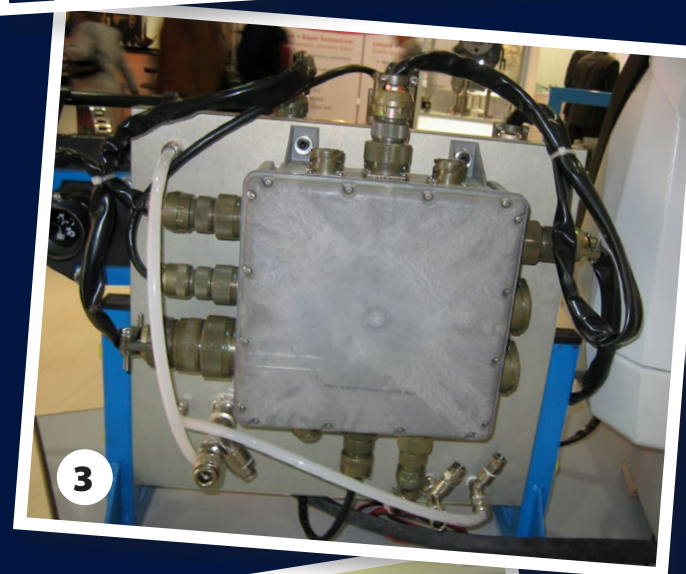

3

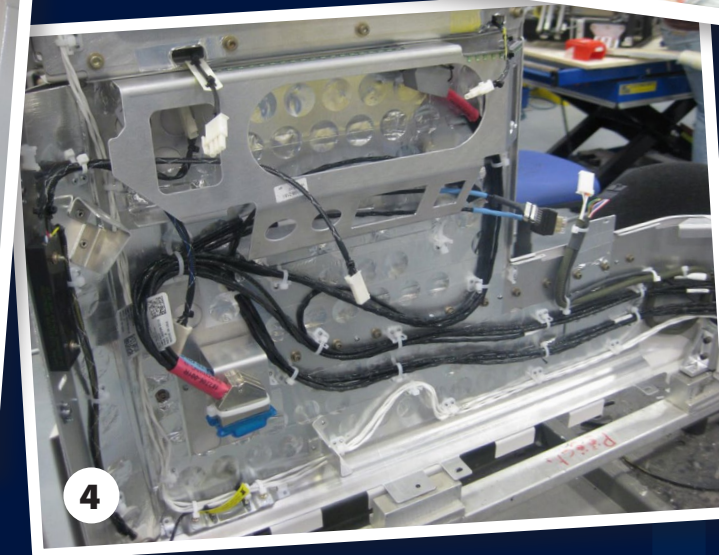

4

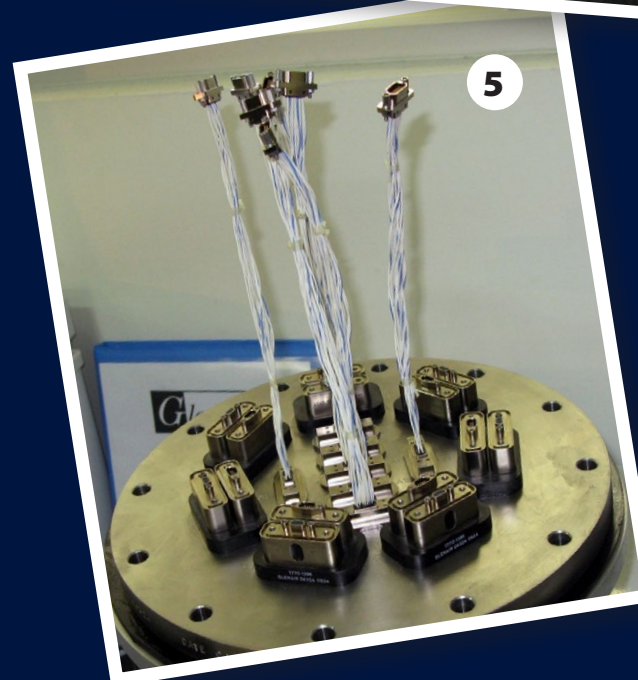

5

**Integrated Systems:** all interconnect components, boxes and machined chassis manufactured by Glenair. All cabling and final integration completed by Glenair. Glenair engineering provides extensive design support throughout.

Figure 1: Integrated in-flight entertainment console and cabling

Figure 2: Wired unmanned vehicle control module

Figure 3: Rail industry corrosion-resistant junction box assembly

Figure 4: Business-class seat chassis with integrated cabling

Figure 5: Stainless steel vacuum plate with machine-integrated Micro-D connectors and jumpers





# COMPLEX CABLE Factory Tour

Glenair's Complex Cable Group (CCG) has delivered creative engineering, high-quality workmanship, fast response, and on-time delivery to countless mission-critical interconnect customers for over 60 years. The operation—from cable design through fabrication, test, and delivery—is fully integrated into Glenair's Glendale campus, ISO 9001 and AS9100 quality system, and high availability business model.



▶ High-speed production overmolding

▶ Commander Ed White's "Golden Umbilical," with space-grade radiation shielding



▶ Multibranch assembly with lightweight ArmorLite™ microfilament EMI/RFI overbraid



▶ Continuity testing standard on all cable circuits



▶ Reliable Band-Master ATS® EMI/RFI shield termination technology used extensively throughout the shop



▶ CCG manufacturing engineering team designs and builds custom jigs and fixtures

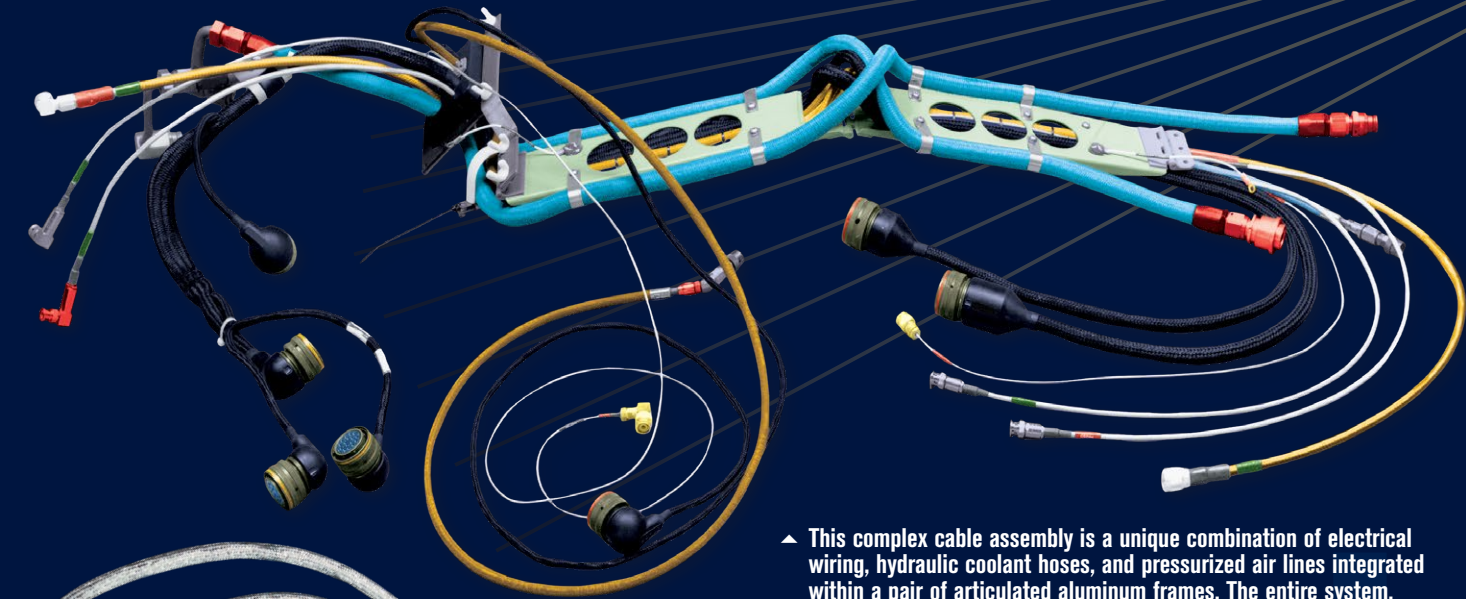

▶ This complex cable assembly is a unique combination of electrical wiring, hydraulic coolant hoses, and pressurized air lines integrated within a pair of articulated aluminum frames. The entire system, including coolant hoses, is assembled and tested according to customer specifications.



▶ ArmorLite microfilament overbraided EMI/RFI assembly



▶ Creative and practical layout boards ensure final fit and function



▶ Skilled technicians produce made-to-measure multi-branch assemblies to exact dimensional tolerances

▶ Complete coverage of cable interstices in overbraided assemblies





# MISSION-CRITICAL INTERCONNECT SOLUTIONS

## Glenair, Inc.

1211 Air Way • Glendale, California • 91201-2497

Telephone: 818-247-6000 • Fax: 818-500-9912 • sales@glenair.com

[www.glenair.com](http://www.glenair.com)

### Glenair Power Products Group

860 N. Main Street Extension  
Wallingford, CT  
06492

Telephone:  
203-741-1115  
Facsimile:  
203-741-0053  
sales@glenair.com

### Glenair UK Ltd

40 Lower Oakham Way  
Oakham Business Park  
Mansfield, Notts  
NG18 5BY England

Telephone:  
+44-1623-638100  
Facsimile:  
+44-1623-638111  
sales@glenair.co.uk

### Glenair Microway Systems

7000 North Lawndale Avenue  
Lincolnwood, IL  
60712

Telephone:  
847-679-8833  
Facsimile:  
847-679-8849

### Glenair Nordic AB

Gustav III : S Boulevard 46  
SE-169 27 Solna  
Sweden

Telephone:  
+46-8-50550000  
sales@glenair.se

### Glenair Electric GmbH

Schaberweg 28  
61348 Bad Homburg  
Germany

Telephone:  
06172 / 68 16 0  
Facsimile:  
06172 / 68 16 90  
info@glenair.de

### Glenair Iberica

C/ La Vega, 16  
45612 Velada  
Spain

Telephone:  
+34-925-89-29-88  
Facsimile:  
+34-925-89-29-87  
sales@glenair.es

### Glenair Italia S.p.A.

Via Del Lavoro, 7  
40057 Quarto Inferiore –  
Granarolo dell'Emilia  
Bologna, Italy

Telephone:  
+39-051-782811  
Facsimile:  
+39-051-782259  
info@glenair.it

### Glenair France SARL

7, Avenue Parmentier  
Immeuble Central Parc #2  
31200 Toulouse  
France

Telephone:  
+33-5-34-40-97-40  
Facsimile:  
+33-5-61-47-86-10  
sales@glenair.fr

### Glenair Korea

B-1304 Gunpo IT Valley  
148 Gosan-Ro, Gunpo-Si  
Kyunggi-Do, Korea  
435-733

Telephone:  
+82-31-8068-1090  
Facsimile:  
+82-31-8068-1092  
sales@glenair.kr

